

# Insulation Requirements

Insulation requirements depend upon where water service pipes are installed, on the pipe size, material and internal bore. It also depends on the position of the duct and if the floor is solid or suspended. Pipework must be insulated to provide at least 12 hours protection to meet the Regulator's minimum standards.

Any pipe outside of the thermal envelope requires extreme protection. Examples of pipes outside the thermal envelope include pipes above the ceiling insulation in a roof space, and pipes under suspended ground floors, pot and beam floors, or in unheated communal areas, cloakrooms, store rooms, utility rooms, garages, external locations etc.

Therefore any part of the pipe in a duct that is outside the thermal envelope should be insulated to protect against extreme conditions. Insulation should be of the 'closed cell' type and be tubular to ensure an equal thickness around the pipe. The seam should also be sealed in accordance with manufacturer's instructions and the thermal conductivity should be 0.035 also known as W35 standard.

**Note:** Rockwool/fibre glass insulation types are not acceptable for external use.

As it is sometimes difficult to determine what is and what isn't outside the thermal envelope, the following guide should apply to both commercial and domestic water service pipe installations and we would strongly recommend exceeding the minimum requirements wherever possible.

This is the link for the pipe insulation tool:

[www.waterregsuk.co.uk/information/tools/pipe\\_insulation\\_tool/](http://www.waterregsuk.co.uk/information/tools/pipe_insulation_tool/)

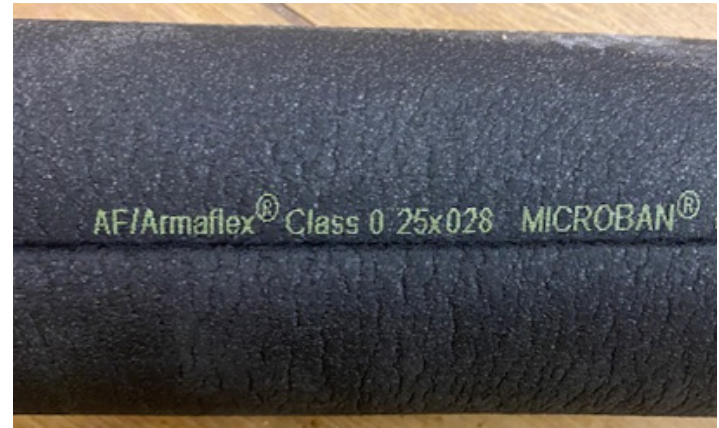

# Insulation Requirements

**Insulation wall thickness for domestic properties in normal conditions**

Size of supply	Material	Minimum insulation requirements
25mm	PE/Barrier Pipe	25mm wall
32mm	PE/Barrier Pipe	19mm wall
63mm	PE/Barrier Pipe	6mm wall
90mm	PE/Barrier Pipe	6mm wall
110mm	PE/Barrier Pipe	6mm wall
160mm	PE/Barrier Pipe	6mm wall

**Insulation wall thickness for domestic properties in extreme conditions**

Size of supply	Material	Minimum insulation requirements
25mm	PE/Barrier Pipe	32mm wall
32mm	PE/Barrier Pipe	19mm wall
63mm	PE/Barrier Pipe	6mm wall
90mm	PE/Barrier Pipe	6mm wall
110mm	PE/Barrier Pipe	6mm wall
160mm	PE/Barrier Pipe	6mm wall

**Insulation wall thickness for commercial properties in normal conditions**

Size of supply	Material	Minimum insulation requirements
25mm	PE/Barrier Pipe	32mm wall
32mm	PE/Barrier Pipe	19mm wall
63mm	PE/Barrier Pipe	6mm wall
90mm	PE/Barrier Pipe	6mm wall
110mm	PE/Barrier Pipe	6mm wall
160mm	PE/Barrier Pipe	6mm wall

**Insulation wall thickness for commercial properties in extreme conditions**

Size of supply	Material	Minimum insulation requirements
25mm	PE/Barrier Pipe	32mm wall
32mm	PE/Barrier Pipe	32mm wall
63mm	PE/Barrier Pipe	13mm wall
90mm	PE/Barrier Pipe	6mm wall
110mm	PE/Barrier Pipe	6mm wall
160mm	PE/Barrier Pipe	6mm wall

# Standard 25mm domestic supply with provision for a 15mm internal AMR meter

The water meter should be located within the property at the point of entry.

You must install a suitably approved concentric meter housing on the supply pipe at the point of entry, directly above the stop tap. The meter housing must be able to accommodate the installation of a 15mm meter. **Please note:** Some housings may require a conversion insert. Check with your supplier.

The pipework must be securely fixed to allow the meter to be screwed into the meter housing. A gap of 160mm x 110mm must be left clear directly around the adaptor to accommodate the water meter.

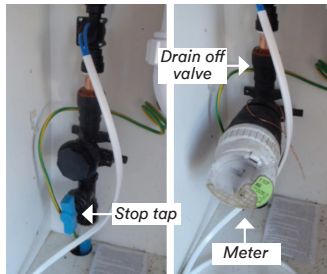

## UUW 15mm and 20mm meter location policy Internal meter installation

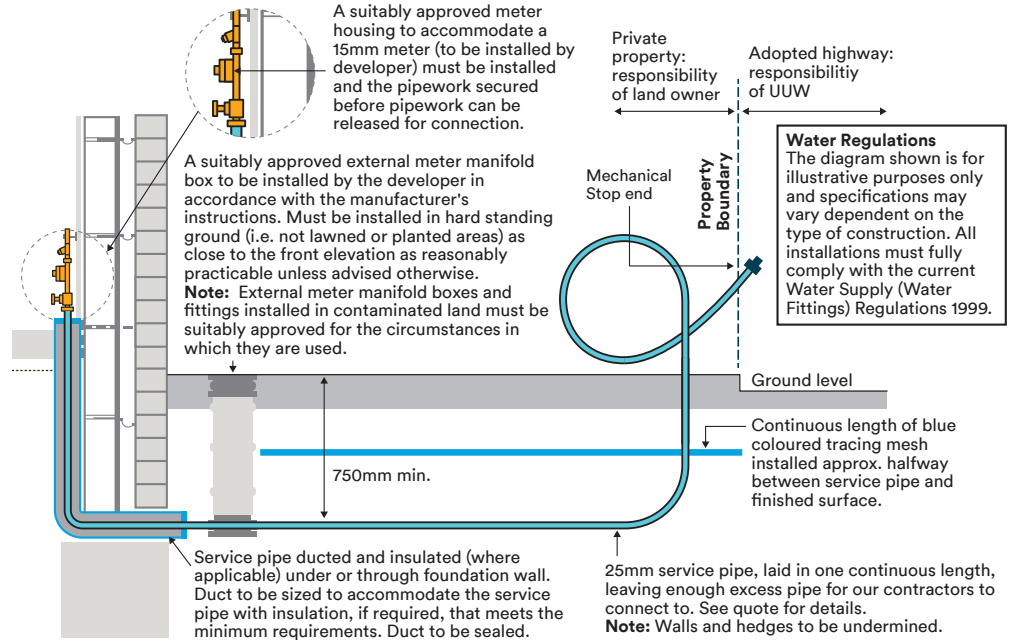

Not to scale

# External meter installation – wall-mounted box

The water meter is located within an approved meter box that is *mounted directly* to the wall.

The meter box can be installed on any elevation of the property and must comply with the specific manufacturer's installation specifications.

No *additional* external control is required.

Ensure **on-wall box** with insulated ducting is installed on the external elevation of the property and an insulated duct through the wall. Pipework to be ducted and appropriately insulated (32mm wall thickness) through the wall and INSUduct will need extending down to 750mm if more than 130mm above ground level.



Wall mounted box together with INSUduct extension

## UUW 15mm meter location policy Wall-mounted box

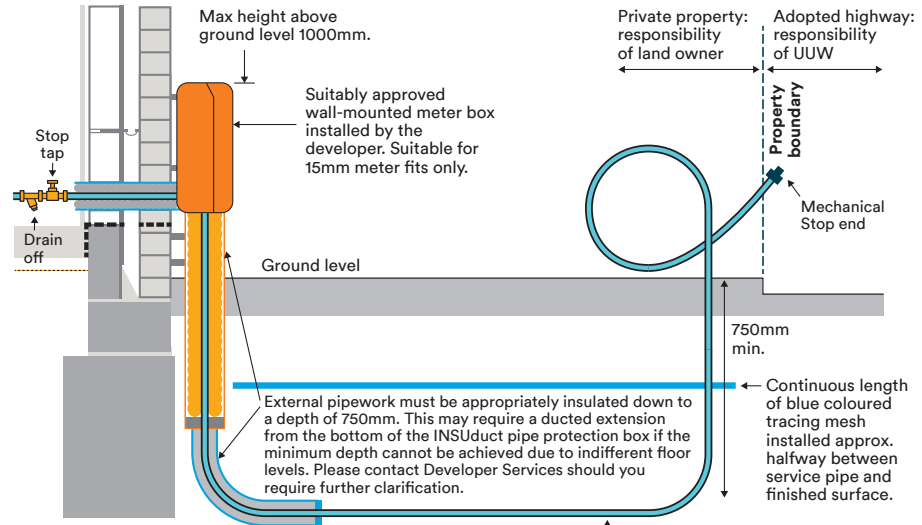

### Water Regulations

The diagram shown is for illustrative purposes only and specifications may vary dependent on the type of construction. All installations must fully comply with current Water Supply (Water Fittings) Regulations 1999.

Service pipe to be laid in one continuous length, leaving enough excess pipe for our contractors to connect to. See quote for details.  
**Note:** Walls and hedges to be undermined.

Not to scale

If the INSUduct box is over 130mm above ground level at final fix, there will be a requirement for you to extend it by using additional ducting and insulation

# Standard 32mm commercial supply with provision for a 20mm – 25mm in-line AMR meter

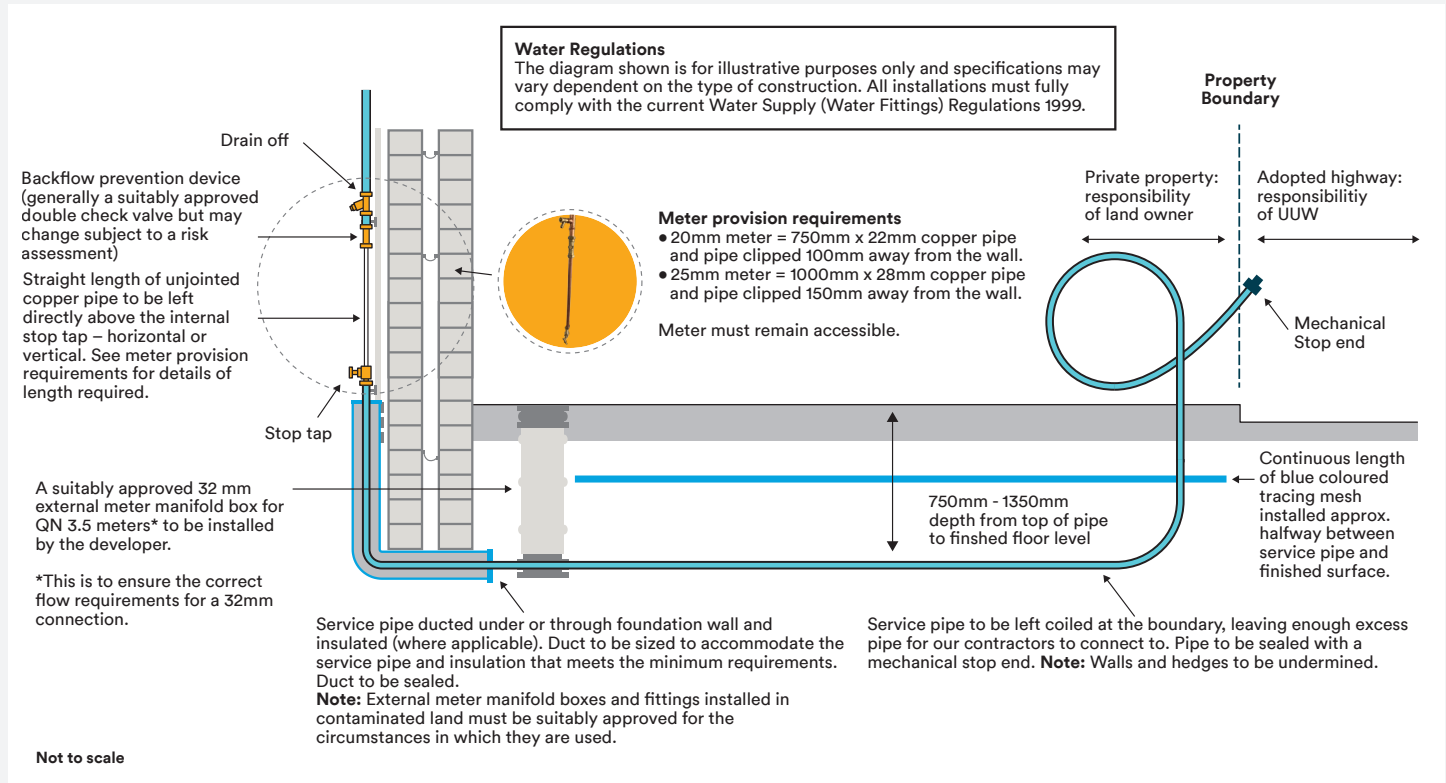

# 32mm commercial basement supply fronting on to the adopted highway with provision for a 20mm-25mm internal in-line meter

**Note:** Be mindful of possible differences in external in internal floor levels. The 750mm minimum requirement is from finished external floor level to the top of the service pipe.

**Property Boundary**

Private property: responsibility of land owner

Adopted highway: responsibility of UUV

**Water Regulations**  
 The diagram shown is for illustrative purposes only and specifications may vary dependent on the type of construction. All installations must fully comply with the current Water Supply (Water Fittings) Regulations 1999.

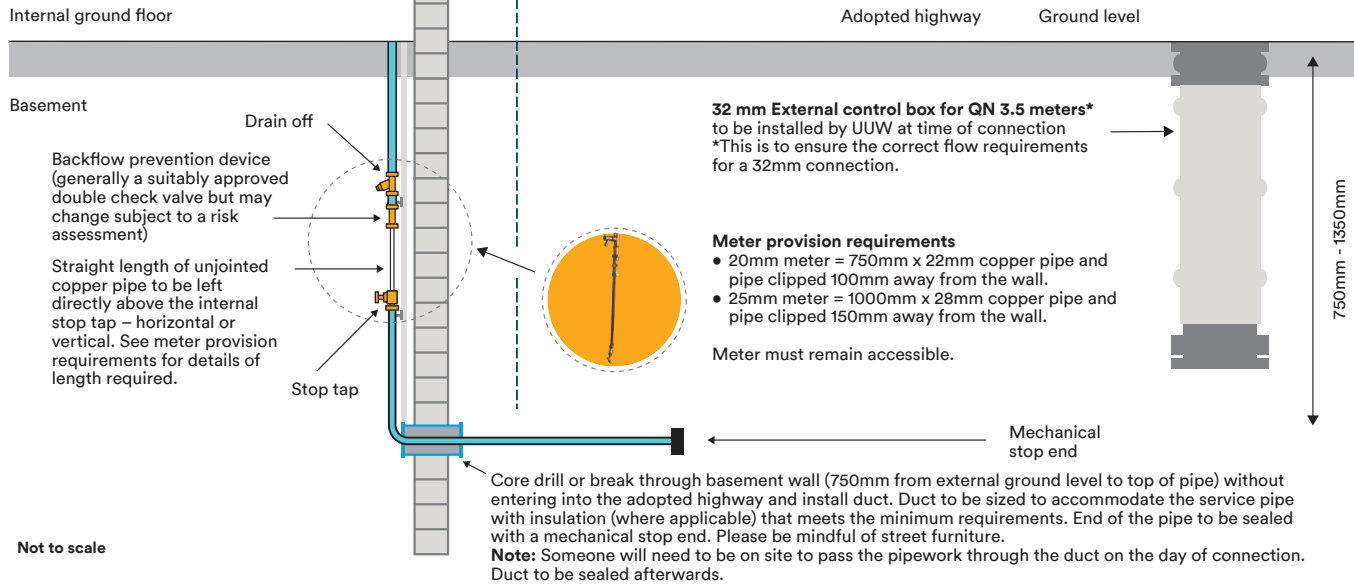

# 25mm commercial basement supply fronting on to the adopted highway with provision for a 15mm screw-in AMR meter

**Note:** Be mindful of a possible difference in external and internal floor levels. The 750mm minimum requirement is from finished external floor level to the top of the service pipe.

**Property Boundary**

Private property: responsibility of land owner  
 Adopted highway: responsibility of UUW

**Water Regulations**  
 The diagram shown is for illustrative purposes only and specifications may vary dependent on the type of construction. All installations must fully comply with the current Water Supply (Water Fittings) Regulations 1999.

Internal ground floor

Basement

Adopted highway Ground level

Drain off

Backflow prevention device (generally a suitably approved double check valve but may change subject to a risk assessment)

Suitably approved meter housing

Stop tap



Suitably approved concentric meter housing. To be installed by developer. This must be installed before pipework is passed for connection. Pipework must be securely fixed to allow meter to be fitted into the meter housing.

Meter must remain accessible.

An external control box will be fitted by UUW at time of connection.

750mm - 1350mm

Mechanical stop end

Core drill or break through basement wall (750mm from external ground level to top of pipe) without entering into the adopted highway and install duct. Duct to be sized to accommodate the service pipe with insulation (where applicable) that meets the minimum requirements. End of the pipe to be sealed with a mechanical stop end. Please be mindful of street furniture

**Note:** Someone will need to be on site to pass the pipework through the duct on the day of connection. Duct to be sealed afterwards.

Not to scale

# 25mm domestic basement supply fronting onto the adopted highway with provision for a 15mm screw in AMR meter

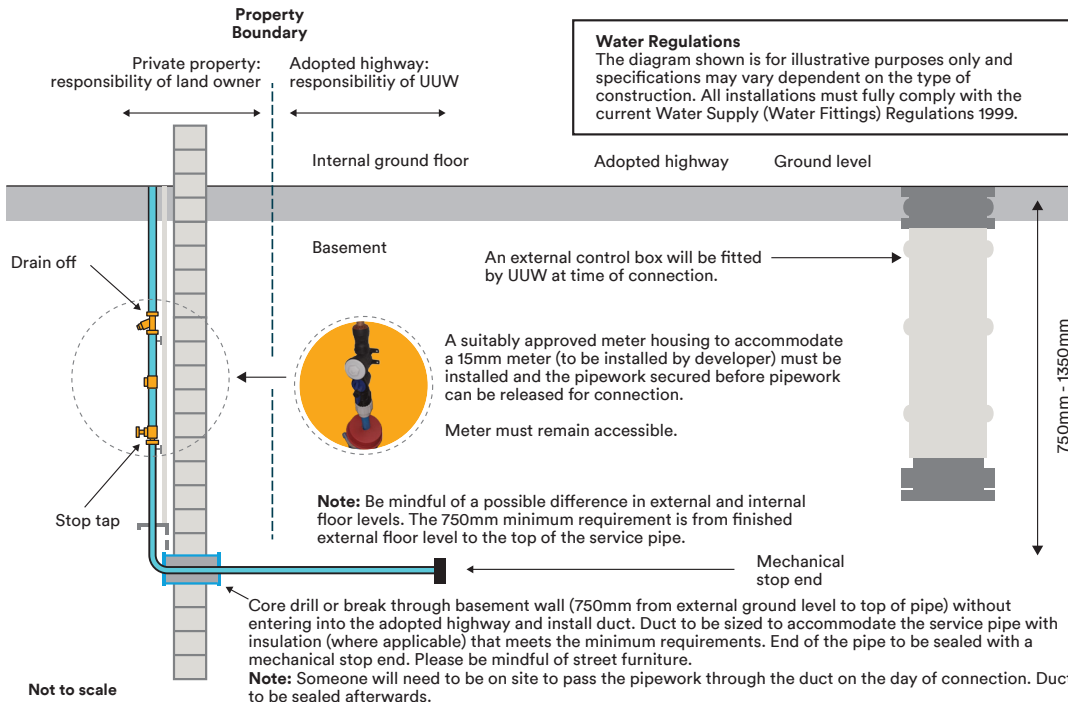

Example of a service pipe being ducted and insulated through a basement wall





# Multi occupancy premises – 32mm connection fronting on to the adopted highway

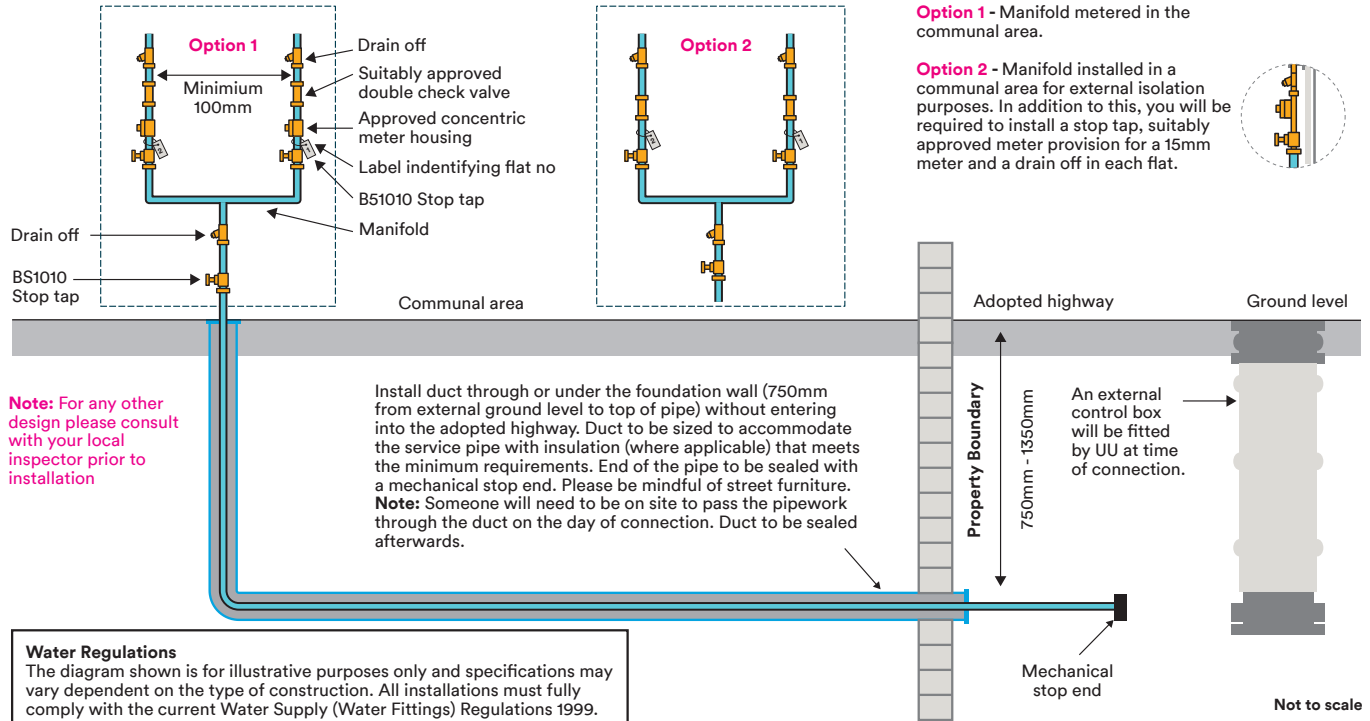

# Temporary building supplies and standpipes

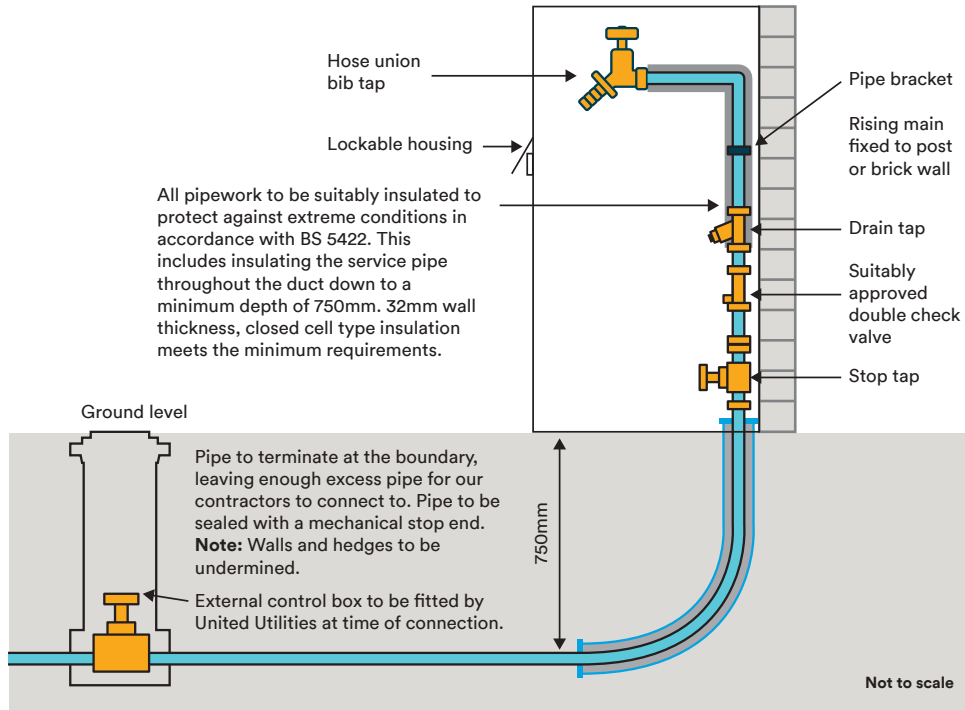

Temporary building supplies must be suitably insulated and housed in a lockable box and the supply pipe should incorporate all the fittings detailed in the diagram on the left.



*This is an example of a lockable box referenced in the spec drawing on the left.*

# Standard temporary site cabin supply

Branches to multiple cabins and temporary building water supplies are permitted with the following conditions:

- Pipework is suitably insulated and weatherproofed
- Pipework is securely clipped and free from trip hazards and accidental damage
- Satisfactory secondary backflow requirements are fulfilled

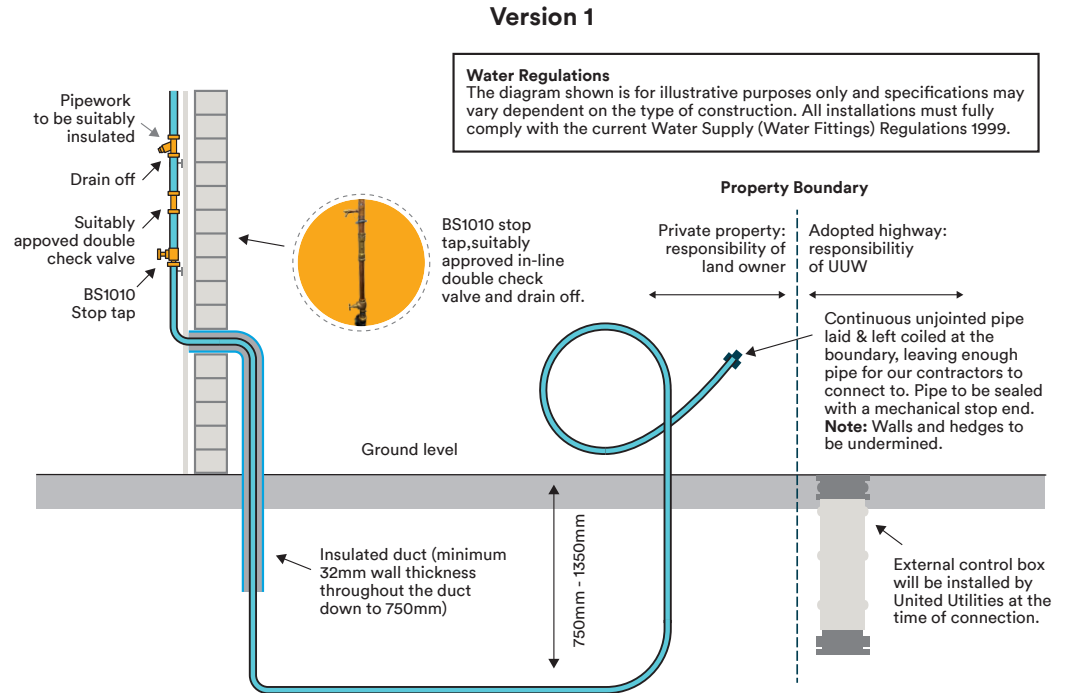

Not to scale

# Standard temporary site cabin supply

## Version 2

### Water Regulations

The diagram shown is for illustrative purposes only and specifications may vary dependent on the type of construction. All installations must fully comply with the current Water Supply (Water Fittings) Regulations 1999.

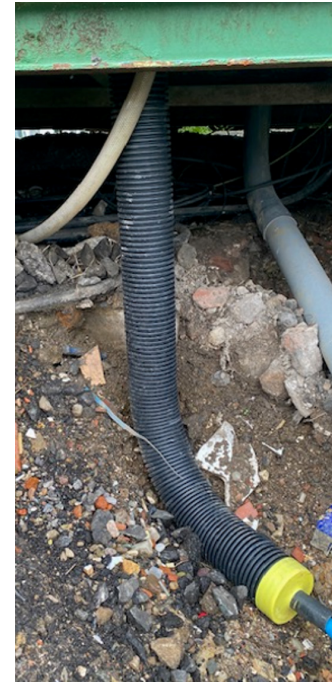
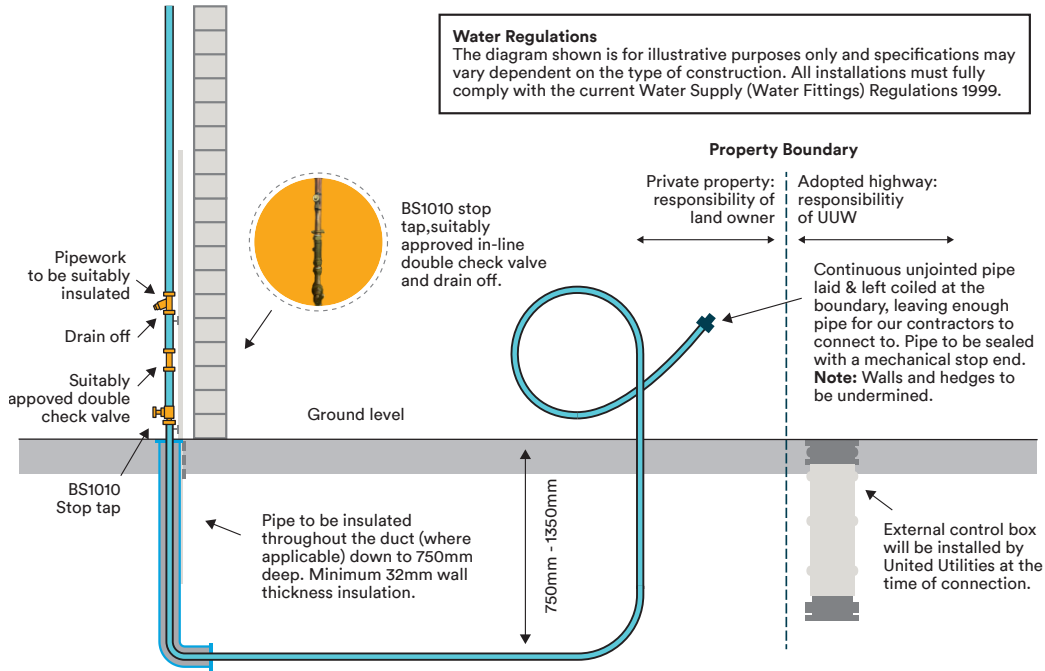

Example of a bottom entry supply prior to backfilling

# Domestic Fire-Fighting Supplies

United Utilities cannot guarantee pressure or flow for any fire-fighting supplies as this is limited to the water available in the network at any time. The network pressure and flow is designed to cater for non-fire-fighting purposes.

United Utilities cannot provide specific design advice for fire-fighting systems. This should be provided by a qualified fire specialist/designer/installer in line with the relevant standards.

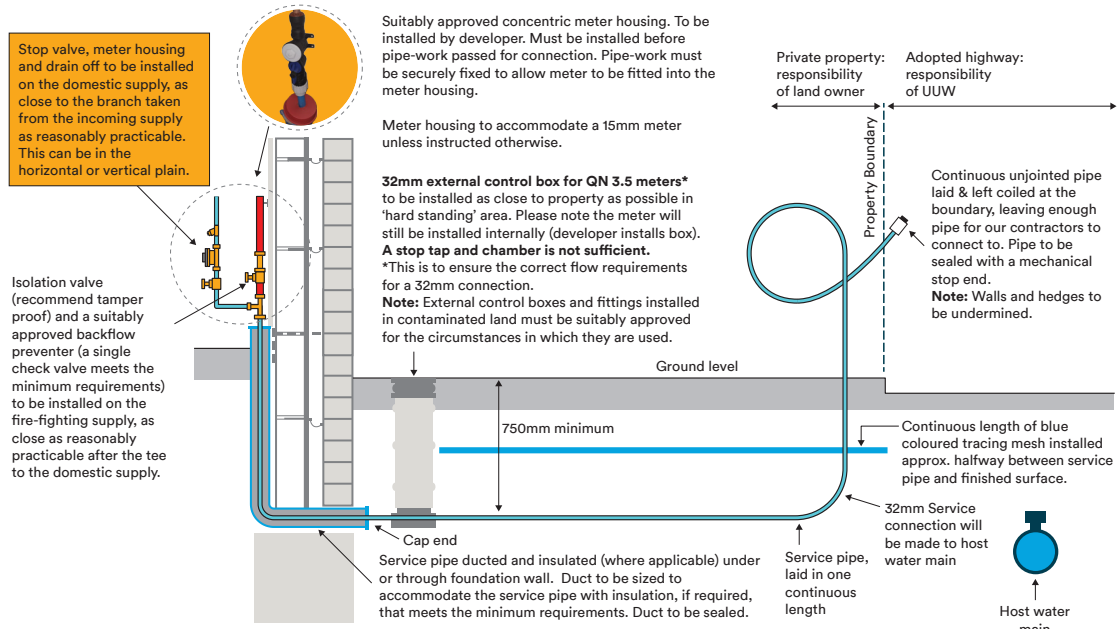

**Water Regulations**  
 The diagram shown is for illustrative purposes only and specifications may vary dependent on the type of construction. All installations must fully comply with the current Water Regulations.

Not to scale

# Domestic Fire-Fighting Supplies

Externally metered connection – Generally used for properties that are a minimum 50 metres from the point of connection or where the supply enters a different part of the property.

- Fire-fighting supply pipe to be installed in accordance with BS1710:2014 which provides the standards for pipe ID and includes colour coding requirements, guidance on labels and the contents of pipework
- Isolation valve and suitably approved backflow preventer, generally a single check valve, to be installed in a self-contained chamber, as close as reasonably practicable to the domestic supply pipe branch from which the fire-fighting supply was taken. Chamber to be sized to allow access for maintenance and repair
- Fire-fighting supply to be separately ducted and insulated (where required) into the property but can share the same trench as the domestic supply. Duct to be sized to accommodate the service pipe and insulation
- Service pipe to be laid between 750mm-1350mm and to terminate at the boundary leaving enough excess pipe for our contractors to connect to. Pipe to be sealed with a mechanical stop end.  
**Note:** Walls and hedges to be undermined.

**BS1710:2014** Pipe ID colour banding requirements for fire-fighting supplies:

Fire-fighting system supplied direct from the mains network



**Water Regulations**  
The diagram shown is for illustrative purposes only and specifications may vary dependent on the type of construction. All installations must fully comply with the current Water Regulations.

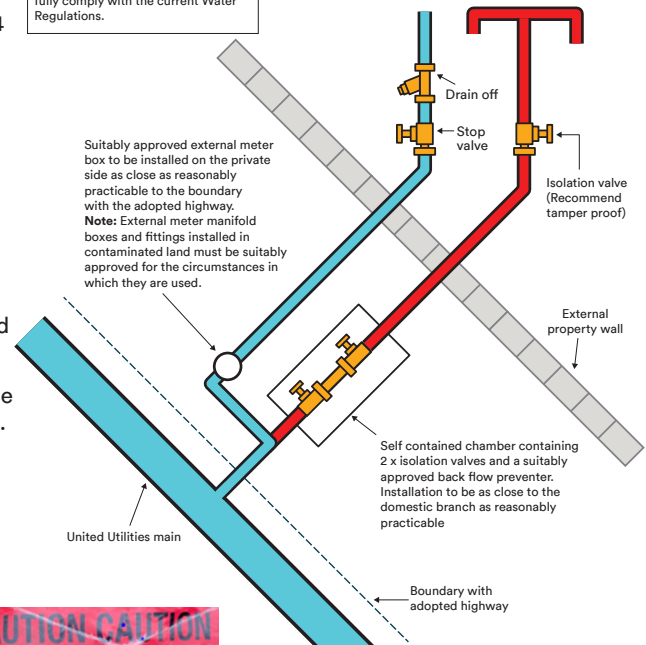

Not to scale

# Agricultural/animal drinking water trough

## Domestic/commercial

### Boundary and point of entry

- The water supply pipe to be laid to the boundary, leaving two metres excess pipe for us to connect to and a mechanical stop end fitted to the end of the pipe
- From the top of the water supply pipe in the trench to the finished floor level must be between 750mm – 1350mm depth and to terminate at the boundary with the adopted highway, leaving enough excess pipe for our contractors to connect to.  
**Note:** Walls and hedges to be undermined.
- Trench to be free from debris and left open for inspection
- Every pipe supplying a drinking trough or bowl must be fitted with a float-operated valve or no other less effective device
- The inlet valve must be securely fixed to the trough and the water inlet point must have an AA air gap or the equivalent fluid category 5 backflow protection
- Water supply pipe to be protected from damage by cattle, horses etc; rising pipe to be ducted and insulated at the trough location, from a minimum 750mm down, up to at least floor level, ideally beyond; insulation to be continued to the inlet of the float valve
- A 100mm duct (solid or flexi but not land drainage) should be sufficient for 25mm and 32mm supplies
- 32mm wall thickness insulation with a thermal conductivity of 0.035 will meet the minimum recommended standards for 25mm and 32mm supplies

- All insulation exposed to the elements should be protected with a weatherproofed tape
- The duct to be sealed using an end cap or with a readily removable sealant (not oil based)
- An isolation valve to be installed just below the inlet to the float valve
- A risk assessment will be required to determine the need for a backflow preventer installation at the boundary with the adopted highway

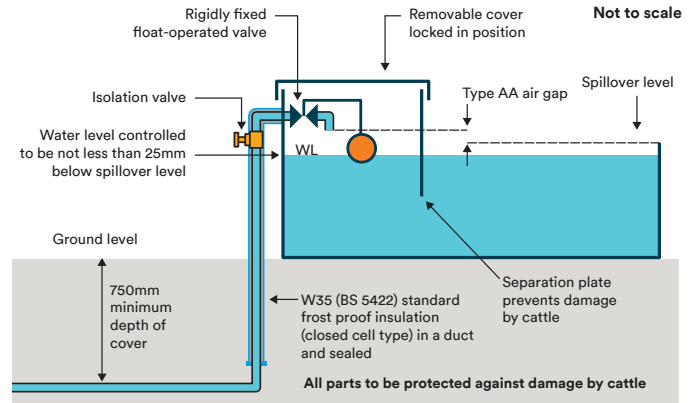

# Shallow entry point Installations

The depth of your water supply pipe should be between 750mm – 1350mm from the top of the pipe to the finished ground level. Should you be prevented from achieving the minimum requirements at the point of entry to the property due to circumstances beyond your control e.g. a ring beam; you can compensate for lack of ground cover by extending your duct out from the property to a point where you can achieve a minimum 750mm ground cover and then insulate to protect against extreme conditions back through to the internal floor level. This may also require the relocation of your external meter box.

Duct to be sealed with an end cap or a readily removable sealant that isn't oil based.

**Note:** Insulated ducting is not an alternative to meeting the minimum requirements for depth.

Any duct that is not blue must be identified by spiral wrapping blue ID tape around the duct if it travels beyond the foundations of the building. Picture 4 and 5 taken prior to spiral wrapping.

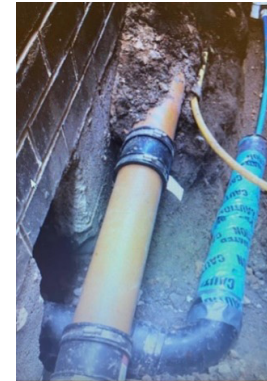



# Rainwater harvesting systems

United Utilities' have identified rainwater harvesting systems as the single biggest threat to water quality if they are not installed correctly, and so your installer's familiarity with the Water Supply (Water Fittings) Regulations 1999 and the British Standard for pipe identification markings (BS1710: 2014) is fundamental to a compliant installation.

**BS1710:2014** provides the standards for pipe ID and includes colour coding requirements, guidance on labels and the contents of pipework. The purpose of this requirement is to prevent accidental cross-connections that could lead to contamination of wholesome water in supply pipes or distributing pipes.

**The Water Supply (Water Fittings) Regulations 1999** detail the national requirements for the design, installation, composition and maintenance of water fittings. These Regulations make provision to stop the waste, misuse, undue consumption, erroneous measurement and most importantly the contamination of the drinking water supply.

## Key installation points to note

- Strictly no cross connections between mains cold water and harvested water are permitted. It is therefore essential that harvested water pipework is kept totally separate from mains water pipework. Non-return valves, check valves, RPZ valves and motorised valves are not a permitted form of separation
- All harvested rainwater pipework, below and above ground, must be identified in accordance with BS1710:2014. Signage

may also be required, clearly stating "not suitable for drinking." This includes the internal pipework that delivers water around commercial and domestic properties, to outlets and appliances such as washing machines and external taps.

- A mains cold water top up to harvested water storage cisterns should incorporate fluid category 5 protection (type AA or type AB air gap) and the branch to the cistern should be fitted with an isolation valve and a suitably approved single check valve as close as reasonably practicable to the mains cold water pipe work from which the branch is taken

## Pipe marking and label examples

Colour coding chart detailing the pipe marking requirements for rainwater harvesting pipework. Colourfast polyethylene tape to be spirally wrapped along the length of underground pipework from the rainwater harvesting tank to the property. This should include direction of flow arrows and a text box detailing the contents of the pipe.

Water quality					
Non-potable water system derived from any other	Green	Flint grey	Black	Flint grey	Green

# Rainwater harvesting systems

An alternative to the use of underground pipe marking tape is the installation of black/green mdpe pipe specifically manufactured for rainwater harvesting systems in accordance with IGN -9-02-05.

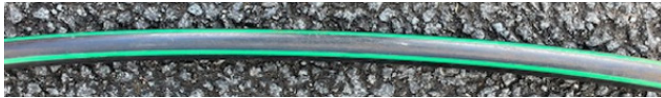

**Note:** Seek advice from your local inspector prior to laying pipework in contaminated ground.

## Warning Tape

Denotes the presence of a supply pipe below. Warning tape to be laid along the whole length of the installation on top of approx. 300mm of back fill. This is in addition to pipe ID.

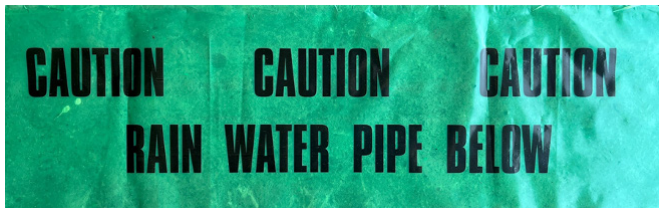

## Internal pipework

The marker tape should still be banded green, flint grey, black, flint grey green and stencilled with whatever fluid family is relevant eg rainwater harvesting. The tape should also incorporate a direction

of flow. In concealed areas marker tape should be applied every 500mm. It should also be applied before and after valves and at a point where the pipe changes direction and either side of any wall a pipe passes through. For any long lengths of pipe we would just be looking for a representative application of marker tape that will make the contents of the pipe easily identifiable.

## Signage

Signage warning that harvested water is not suitable for drinking

## Typical harvested rainwater usage?

- Flushing toilets
- Laundry
- Washing the car
- Watering the garden



## What can you not use harvested rainwater for?

- Drinking
- Cooking
- Washing dishes
- Bathing and personal hygiene

# Water supply pipe installation for allotments with single or multiple watering points

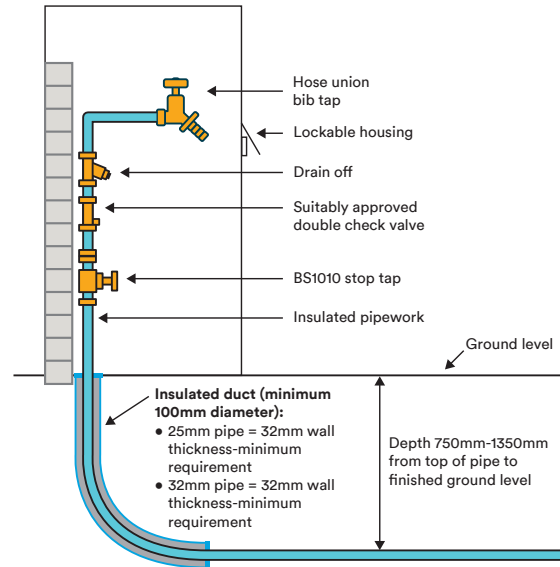
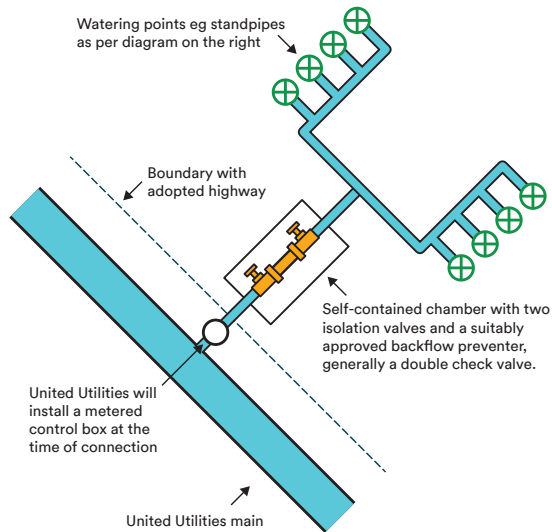
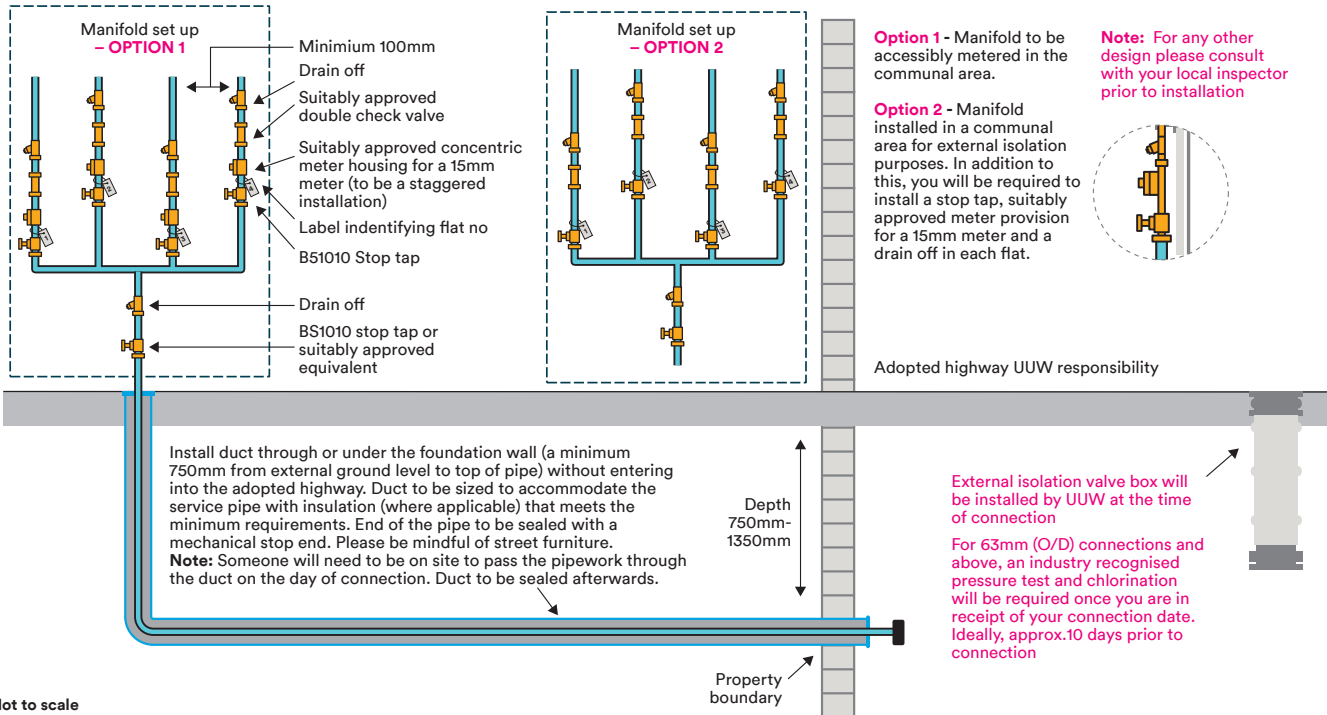

Diagram for guidance only and not to scale – Service pipe to terminate at the point of connection agreed with United Utilities, leaving a minimum of two metres of excess pipe for us to connect to and the end of the pipe to be fitted with a mechanical water tight fitting to prevent the ingress of debris and contaminants. All pipework to be laid between 750mm-1350mm and all branches taken to watering points to be ducted and insulated to protect against extreme conditions. Hose connections to be retractable with a self-closing mechanism and disconnected after use. Watering points to be confirmed for domestic use only (eg watering plants and produce) and installed using the installation details provided. Suitably approved pre-fabricated standpipes can be installed as an alternative to self-constructed ones. No fertilizer attachments allowed and the hose must not be allowed to fall below the spill over level of any vessel that is being topped up. Anything considered beyond domestic use will be subject to a risk assessment to determine the level of backflow protection required. A suitably approved backflow preventer, generally a double check valve, but the level of protection may be increased upon further risk assessment, to be installed as close as reasonably practicable to the boundary and the chamber sized to allow for maintenance and repair.

# Multi-occupancy premises – Non-standard connections (63mm and above) fronting on to the adopted highway



Not to scale

# Multi-occupancy premises – Non-standard connections (63mm and above)

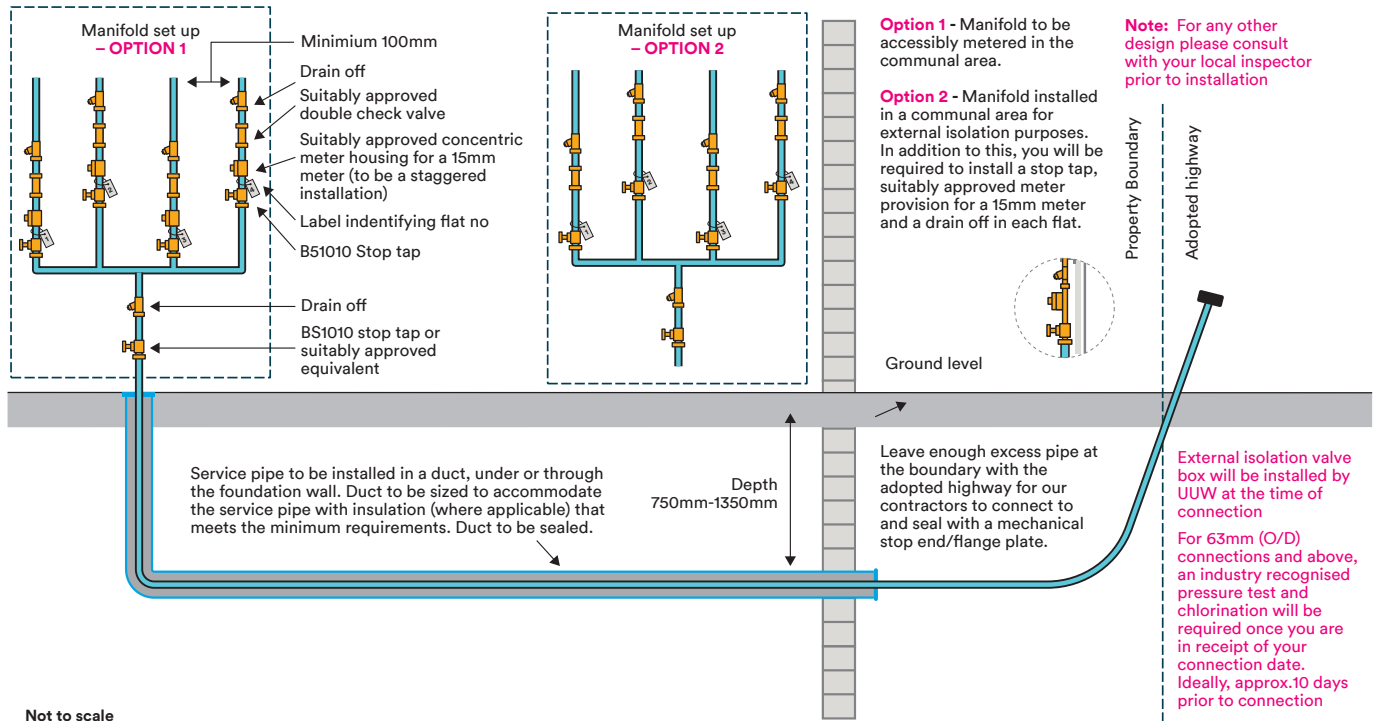

# Multi-occupancy premises – Non-standard basement installation (63mm and above) fronting on to the adopted highway

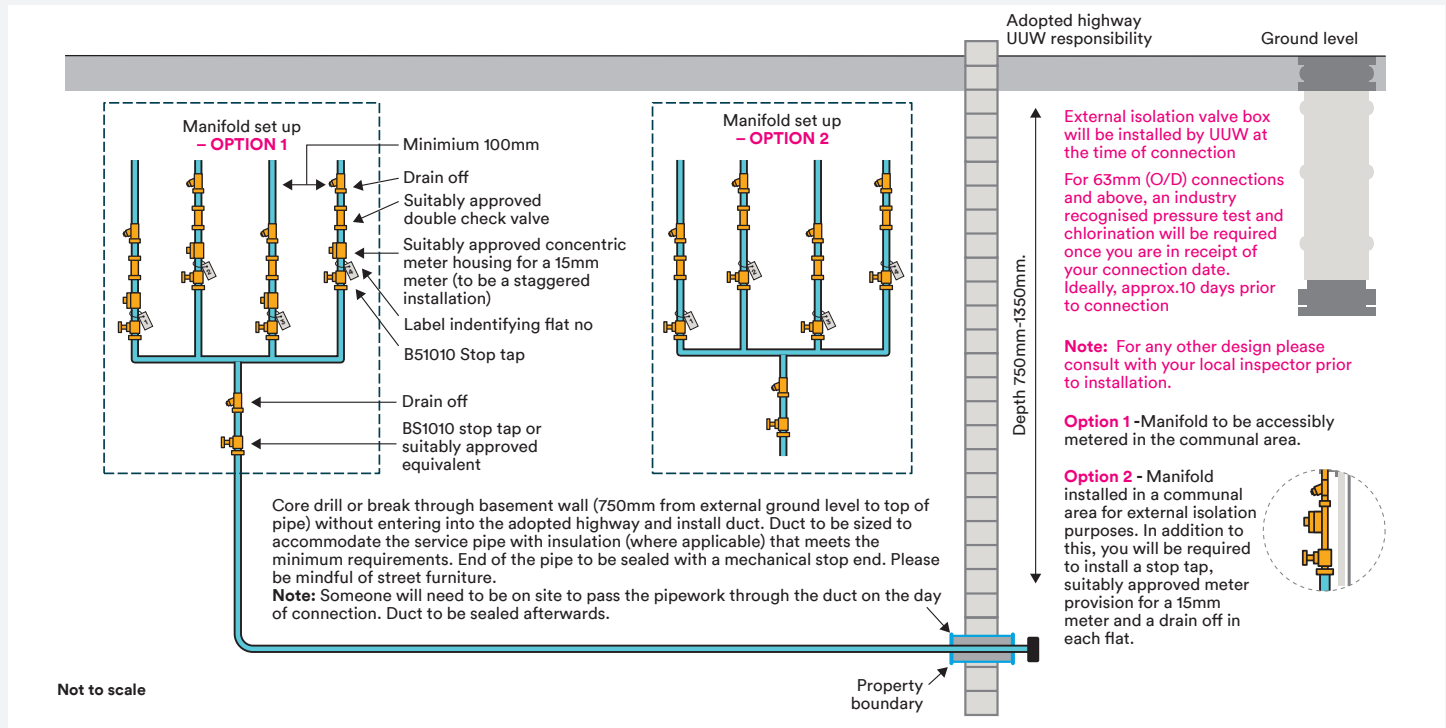

# Non-standard connection with 50mm and above internal in-line meter installation

Not to scale

## Example 1

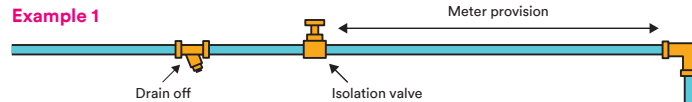

**Example 1** is for a domestic connection where there is no backflow requirement or a commercial installation where the backflow preventer is required to be installed externally at the boundary with the adopted highway.

**Example 2** is a commercial installation with provision for an internal backflow preventer included.

If you are quoted for the water meter to be installed externally, there will be no requirement for internal meter provision.

Please speak to your local inspector for further clarification

## Example 2

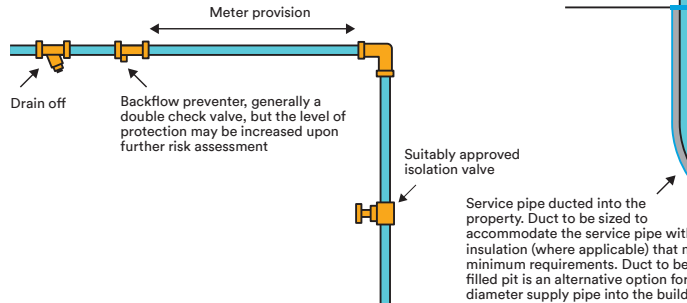

Backflow preventer, generally a double check valve, but the level of protection may be increased upon further risk assessment

Suitably approved isolation valve

Service pipe ducted into the property. Duct to be sized to accommodate the service pipe with insulation (where applicable) that meets the minimum requirements. Duct to be sealed. A soft filled pit is an alternative option for bringing a large diameter supply pipe into the building. Speak to your local inspector for further clarification.

## Internal in-line meter provision for meter sizes 50mm-150mm

Meter provision for all meter fits below should be in the horizontal plain. Clearance for 80mm meters and above TBC.

- 50mm meter** = 1500mm x 54mm unjointed copper pipe in horizontal plain with 250mm clearance for meter install
- 80mm meter** = 2000mm x 76mm unjointed copper pipe
- 100mm meter** = 2500mm x 108mm unjointed copper pipe
- 150mm meter** = 3500mm x 170mm unjointed copper pipe

**Note: These dimensions do not account for the installation of a BACKFLOW PREVENTER, which if required, may need installing in the horizontal plain.**

Pipework to be installed, ideally at waist height, and, adequately supported to take the weight of the fittings to be installed. **Meter sizes 50mm and above generally come with a strainer and will also be fitted in the horizontal plain.**

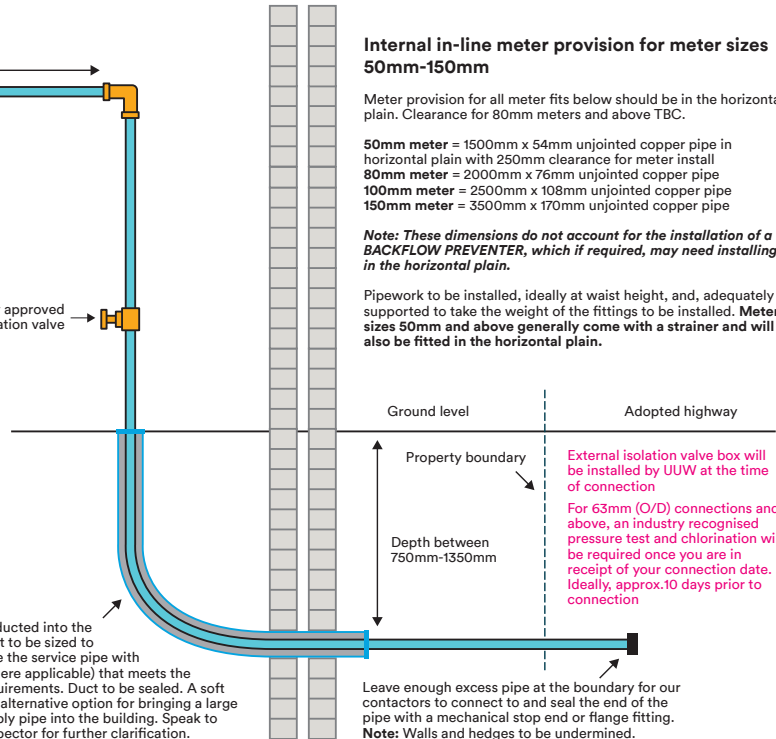

External isolation valve box will be installed by UUV at the time of connection  
For 63mm (O/D) connections and above, an industry recognised pressure test and chlorination will be required once you are in receipt of your connection date. Ideally, approx.10 days prior to connection

Leave enough excess pipe at the boundary for our contractors to connect to and seal the end of the pipe with a mechanical stop end or flange fitting.  
**Note:** Walls and hedges to be undisturbed.

# Installation guidance for an irrigation supply

## General installation requirements

- Pipe to be laid unjointed (if possible) or kept to a minimum, at a depth between 750mm-1350mm
- The supply to the irrigation tank to be ducted and suitably insulated up to ground level, usually through a concrete slab, at the point where the pipe leaves the ground to be taken to the tank inlet
- All remaining pipework exposed to the elements to be adequately insulated to protect against extreme conditions
- Pipework downstream of the irrigation tank to be identifiable by spiral wrapping the pipe in accordance with BS1710:2014
- The tank outlet pipe exposed to the elements to be adequately insulated to protect against extreme conditions and suitably ducted and insulated down to a minimum depth of 750mm when leaving the tank to go below ground
- All underground outlet pipework to be laid between 750mm-1350mm and be suitably ducted and insulated from 750mm up to ground level if being taken above ground
- All exposed pipework thereafter to be adequately insulated to protect against extreme conditions

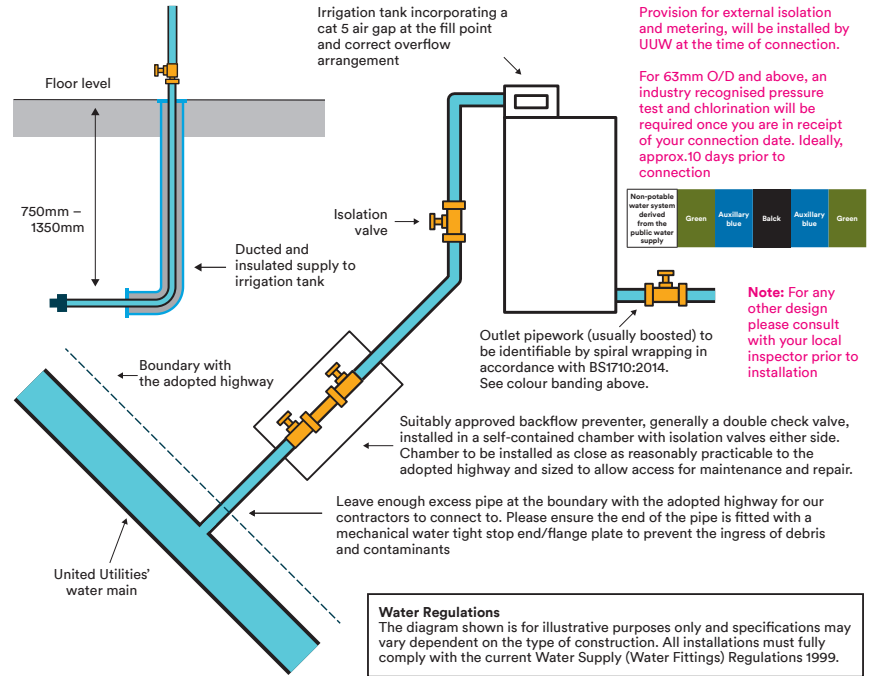

Not to scale



# Non-standard commercial 63mm connection with provision for 25mm - 40mm in-line meters

## Commercial meters

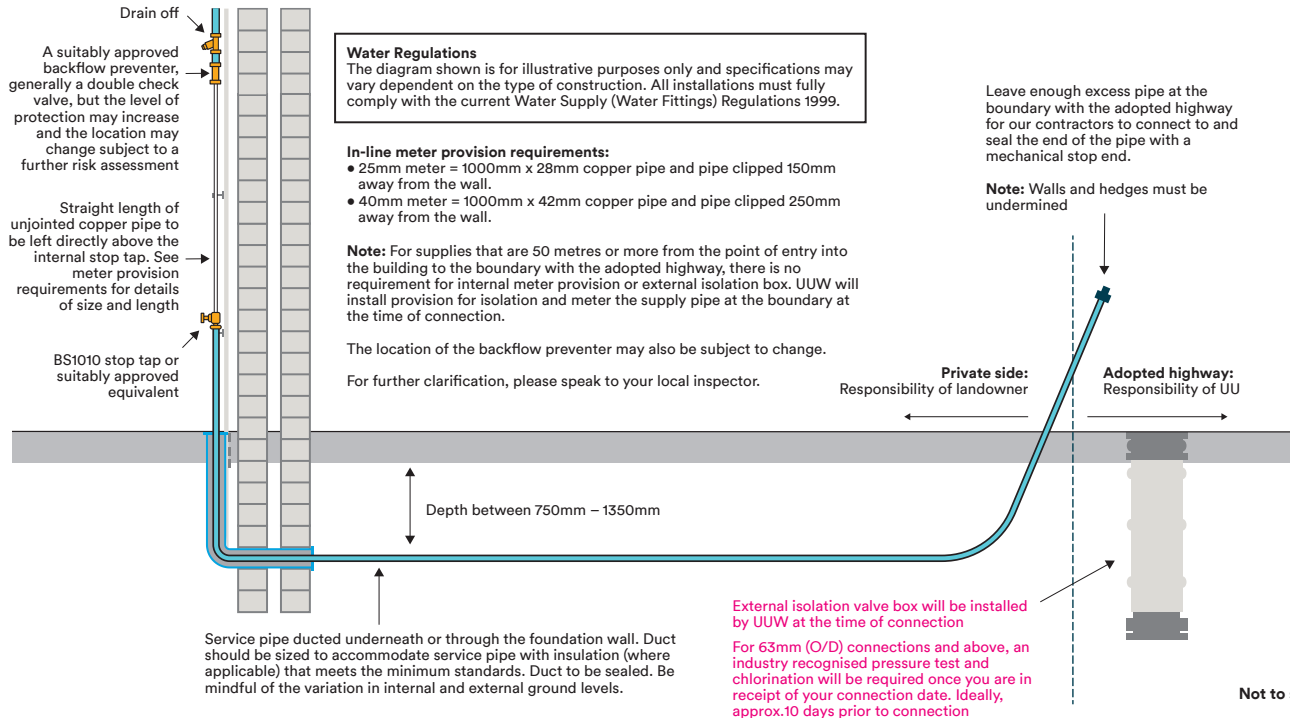

# Non-standard commercial/industrial indirect sprinkler/misting system installation

## Standard Detail:

- Supply pipe to be laid between 750mm-1350mm and to terminate at the boundary with the adopted highway, leaving enough excess pipe for our contractors to connect to
- The end of the supply pipe(s) to be fitted with a mechanical stop end/flange plate
- Pressure test and disinfection required on 63mm (OD) pipes and above
- Exposed pipework to be adequately insulated
- Pipes installed through slab or entering/exiting a building/pump house to be ducted and adequately insulated

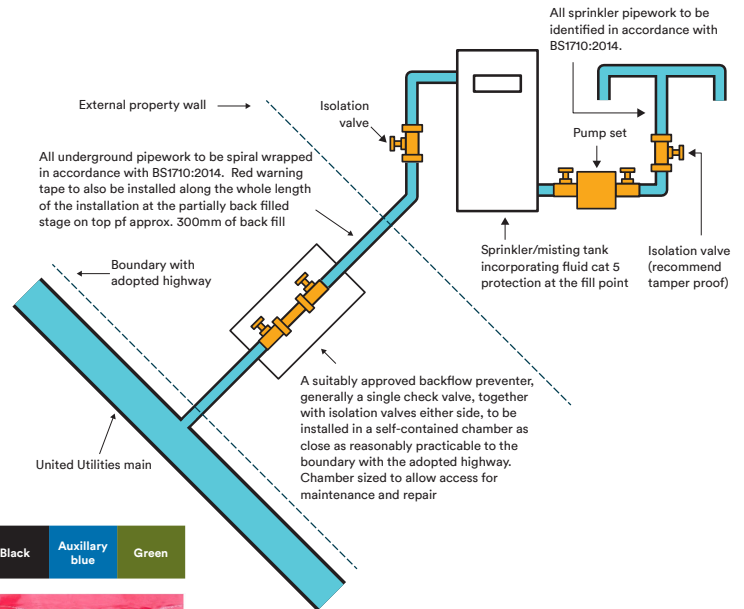

## BS1710:2014 Pipe ID colour coding and ID tape



Not to scale

# Non-standard commercial/industrial boosted fire hydrant main supply

## Standard Detail:

- Supply pipe to be laid between 750mm-1350mm and to terminate at the boundary with the adopted highway, leaving enough excess pipe for our contractors to connect to
- The end of the supply pipe(s) to be fitted with a mechanical stop end/flange plate
- Pressure test and disinfection required on 63mm (OD) pipes and above
- Exposed pipework to be adequately insulated
- Pipes installed through slab or entering/exiting a building/pump house to be ducted and adequately insulated

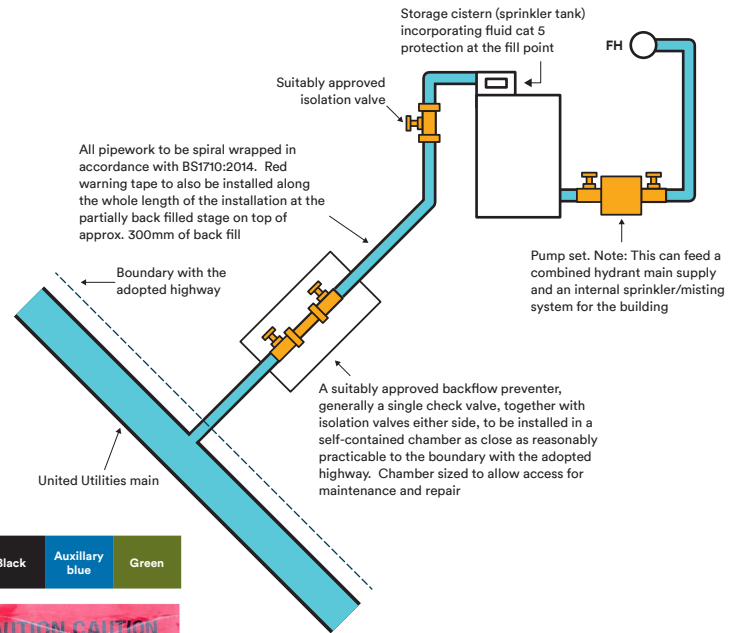

## BS1710:2014 Pipe ID colour coding and ID tape



Not to scale

# Non-standard indirectly boosted sprinkler/misting system supply taken from a domestic multi-occupancy supply

## Standard Detail:

- Supply pipe to be laid between 750mm-1350mm and to terminate at the boundary with the adopted highway, leaving enough excess pipe for our contractors to connect to
- The end of the supply pipe to be fitted with a mechanical stop end/flange plate
- Pressure test and disinfection required on 63mm (OD) pipes and above
- Exposed pipework to be adequately insulated
- Pipes entering/exiting a building/pump house to be ducted and adequately insulated

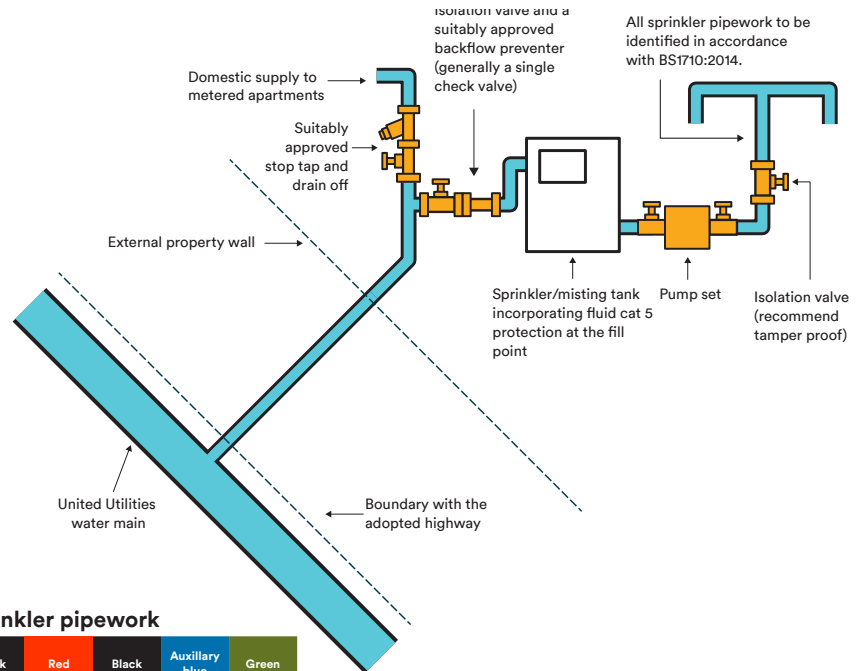

BS1710:2014 Pipe ID colour coding



Not to scale

# Non-standard mains fed commercial/industrial sprinkler/misting system installation

## Standard Detail:

- Supply pipe to be laid between 750mm-1350mm and to terminate at the boundary with the adopted highway, leaving enough excess pipe for our contractors to connect to
- The end of the supply pipe(s) to be fitted with a mechanical stop end/flange plate
- Pressure test and disinfection required on 63mm (OD) pipes and above
- Exposed pipework to be adequately insulated
- Pipes entering/exiting a building to be ducted and adequately insulated

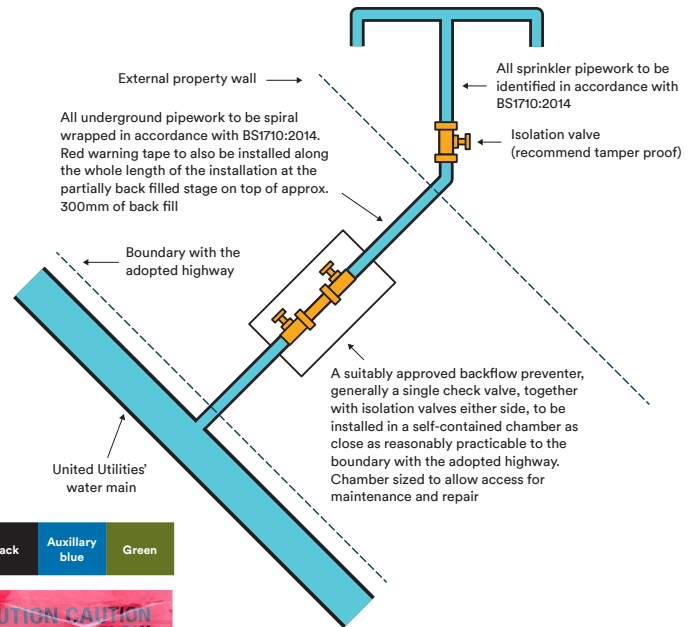

## BS1710:2014 Pipe ID colour coding and ID tape



Not to scale

# Non-standard commercial/industrial mains fed fire-fighting supply installation for a direct feed to fire hydrants

## Standard Detail:

- Supply pipe to be laid between 750mm-1350mm and to terminate at the boundary with the adopted highway, leaving enough excess pipe for our contractors to connect to
- The end of the supply pipe to be fitted with a mechanical stop end/flange plate
- Pressure test and disinfection required on 63mm (OD) pipes and above

## BS1710:2014 Pipe ID colour coding and ID tape

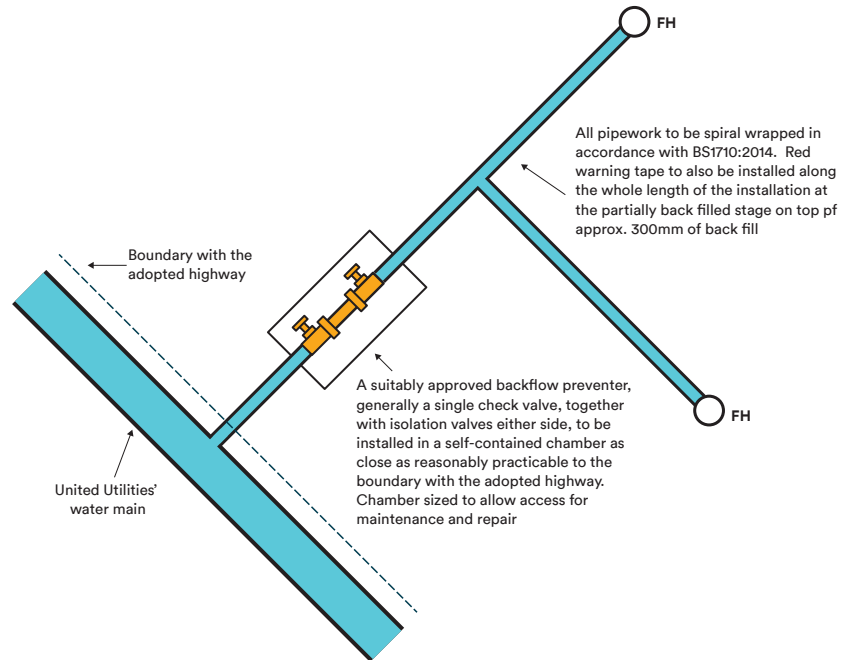
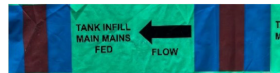

Not to scale

# Non-standard mains fed sprinkler/misting system installation taken from a domestic multi-occupancy supply

## Standard Detail:

- Supply pipe to be laid between 750mm-1350mm and to terminate at the boundary with the adopted highway, leaving enough excess pipe for our contractors to connect to
- The end of the supply pipe(s) to be fitted with a mechanical stop end/ flange plate
- Pressure test and disinfection required on 63mm (OD) pipes and above
- Exposed pipework to be adequately insulated
- Pipes entering/exiting a building to be ducted and adequately insulated

BS1710:2014 Pipe ID colour coding for sprinkler pipework

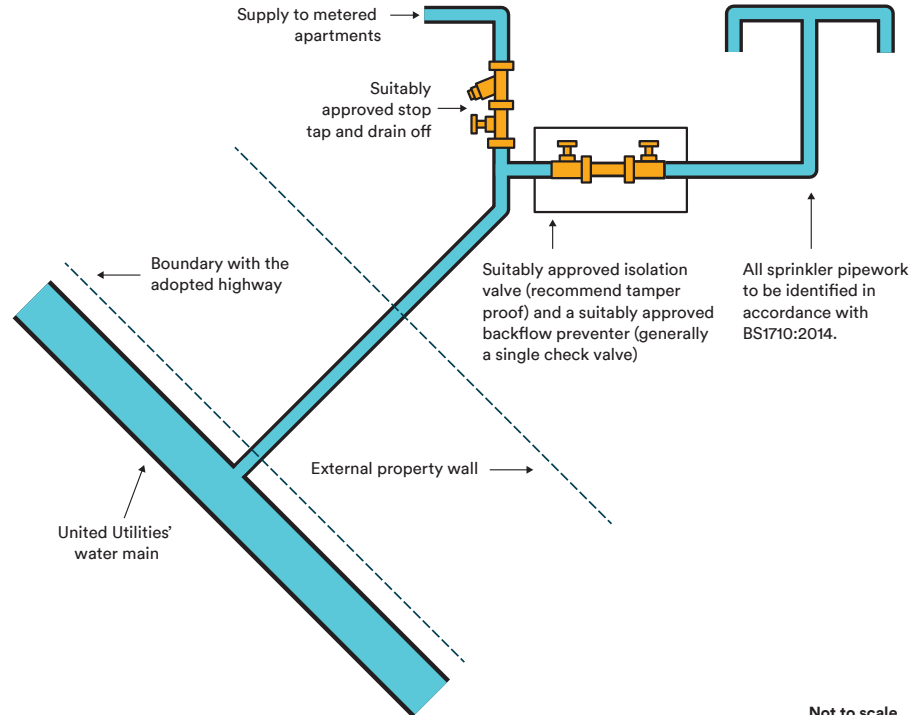

Not to scale

# Standard 25mm and 32mm connections with a supply metered at the boundary

**Important:** All commercial connections will require the installation of a suitably approved backflow preventer, generally a double check valve fitted directly after the first incoming stop tap, but the level of protection may increase and the location may change after a further risk assessment. This is not a standard requirement for single supplies to domestic properties.

**For 32 mm supplies U UW will install a metered control box for QN 3.5 meters\***

**\*This is to ensure the correct flow requirements for a 32mm connection.**

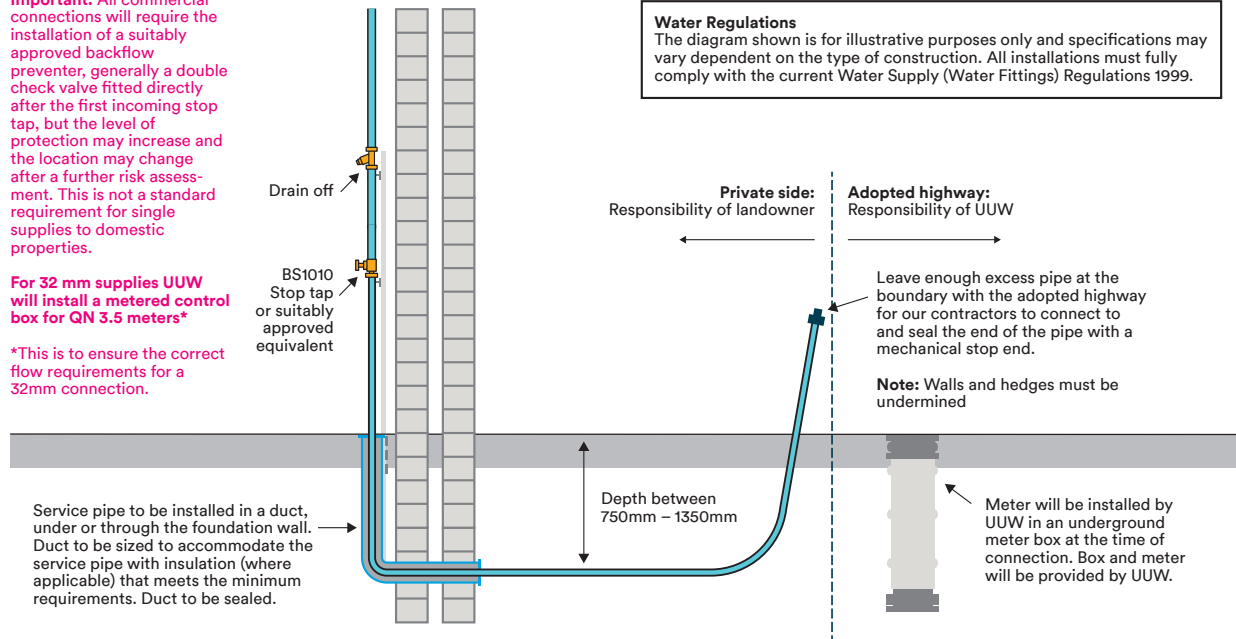

**Water Regulations**  
 The diagram shown is for illustrative purposes only and specifications may vary dependent on the type of construction. All installations must fully comply with the current Water Supply (Water Fittings) Regulations 1999.

Service pipe to be installed in a duct, under or through the foundation wall. Duct to be sized to accommodate the service pipe with insulation (where applicable) that meets the minimum requirements. Duct to be sealed.

Not to scale



# HMO fronting on to the adopted highway with provision for 20mm, 25mm and 40mm in-line meters

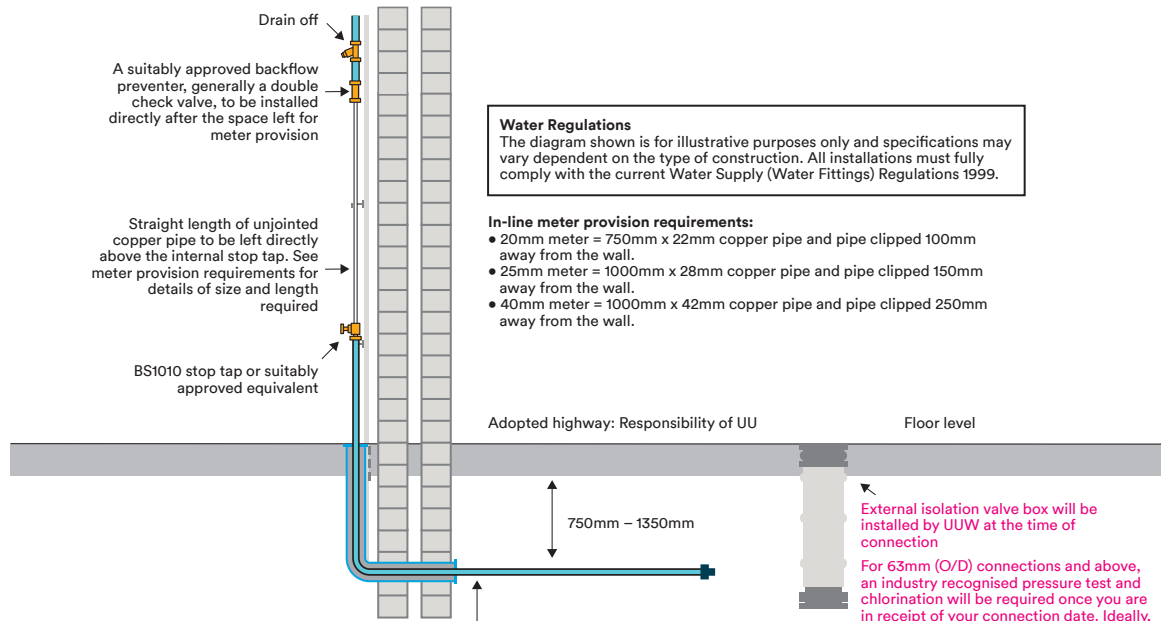

Not to scale

**Water Regulations**  
 The diagram shown is for illustrative purposes only and specifications may vary dependent on the type of construction. All installations must fully comply with the current Water Supply (Water Fittings) Regulations 1999.

- In-line meter provision requirements:**
- 20mm meter = 750mm x 22mm copper pipe and pipe clipped 100mm away from the wall.
  - 25mm meter = 1000mm x 28mm copper pipe and pipe clipped 150mm away from the wall.
  - 40mm meter = 1000mm x 42mm copper pipe and pipe clipped 250mm away from the wall.

A suitably approved backflow preventer, generally a double check valve, to be installed directly after the space left for meter provision

Straight length of unjointed copper pipe to be left directly above the internal stop tap. See meter provision requirements for details of size and length required

BS1010 stop tap or suitably approved equivalent

Adopted highway: Responsibility of UU

Floor level

750mm – 1350mm

External isolation valve box will be installed by UUW at the time of connection

For 63mm (O/D) connections and above, an industry recognised pressure test and chlorination will be required once you are in receipt of your connection date. Ideally, approximately 10 days prior to connection

Install duct through or under the foundation wall (a minimum 750mm from external ground level to top of pipe) without entering into the adopted highway. Duct to be sized to accommodate the service pipe with insulation (where applicable) that meets the minimum requirements. End of the pipe to be sealed with a mechanical stop end. Please be mindful of street furniture.

**Note:** Someone will need to be on site to pass the pipework through the duct on the day of connection. Duct to be sealed afterwards.

# Non-standard 63mm commercial connection fronting on to the adopted highway with provision for 25mm and 40mm in-line meters

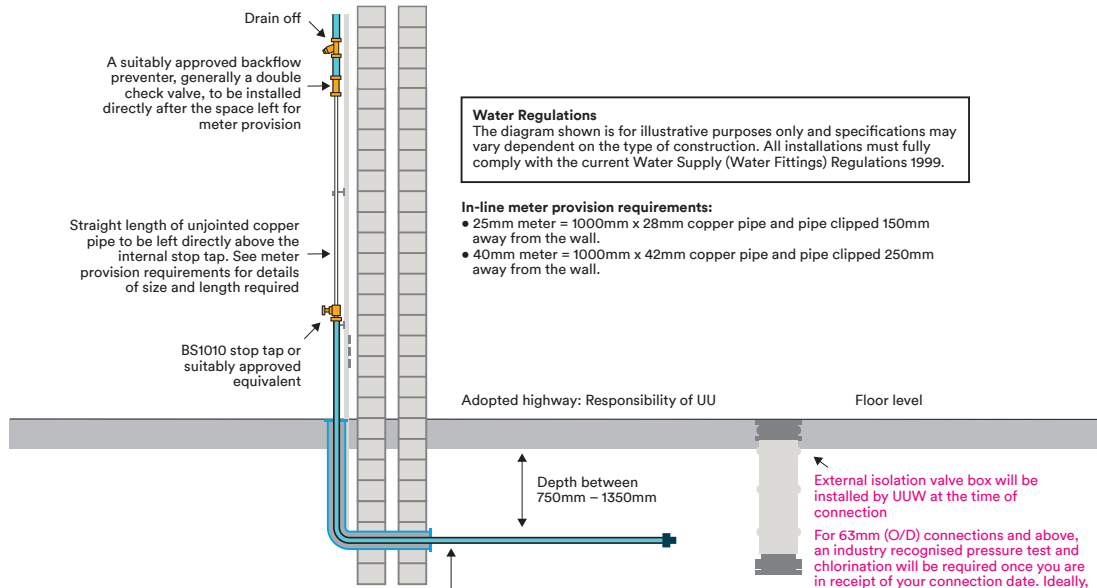

Install duct through or under the foundation wall (a minimum 750mm from external ground level to top of pipe) without entering into the adopted highway. Duct to be sized to accommodate the service pipe with insulation (where applicable) that meets the minimum requirements. End of the pipe to be sealed with a mechanical stop end. Please be mindful of street furniture.  
**Note:** Someone will need to be on site to pass the pipework through the duct on the day of connection. Duct to be sealed afterwards.

External isolation valve box will be installed by UUW at the time of connection  
 For 63mm (O/D) connections and above, an industry recognised pressure test and chlorination will be required once you are in receipt of your connection date. Ideally, approximately 10 days prior to connection

# Non-Standard 63mm commercial basement supply fronting on to the adopted highway with provision for 25mm - 40mm in-line meters

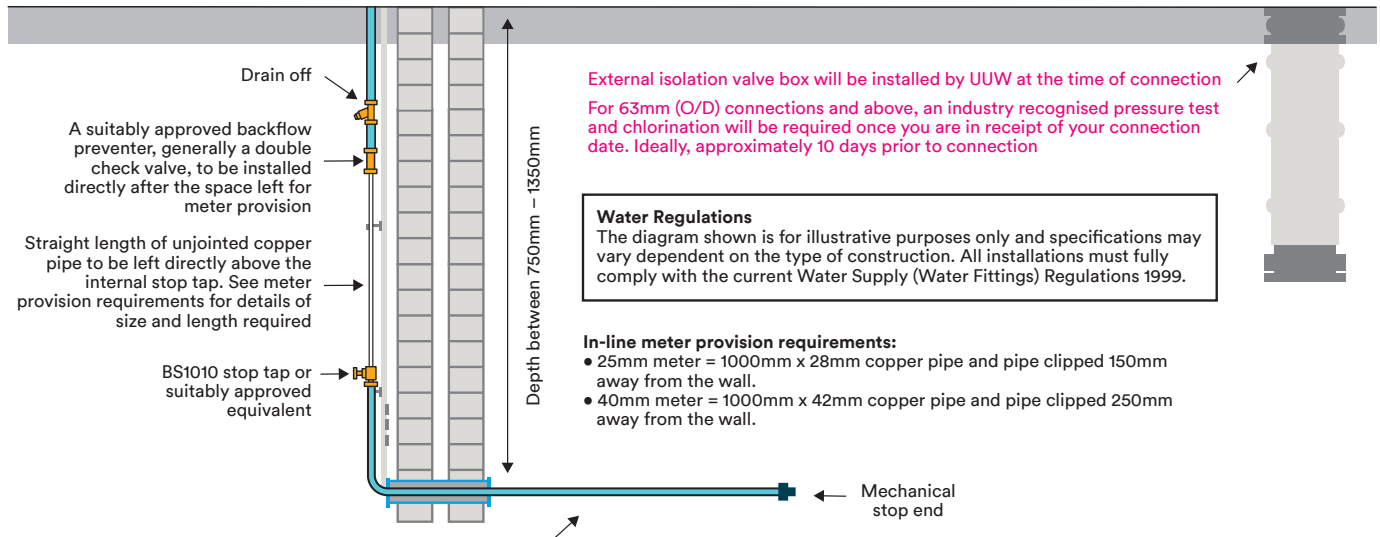

Core drill or break through basement wall (750mm from external ground level to top of pipe) without entering into the adopted highway and install duct. Duct to be sized to accommodate the service pipe with insulation (where applicable) that meets the minimum requirements. End of the pipe to be sealed with a mechanical stop end. Please be mindful of street furniture

**Note:** Someone will need to be on site to pass the pipework through the duct on the day of connection. Duct to be sealed afterwards.

# 25mm domestic/commercial supply fronting onto the adopted highway with provision for a 15mm screw in AMR meter

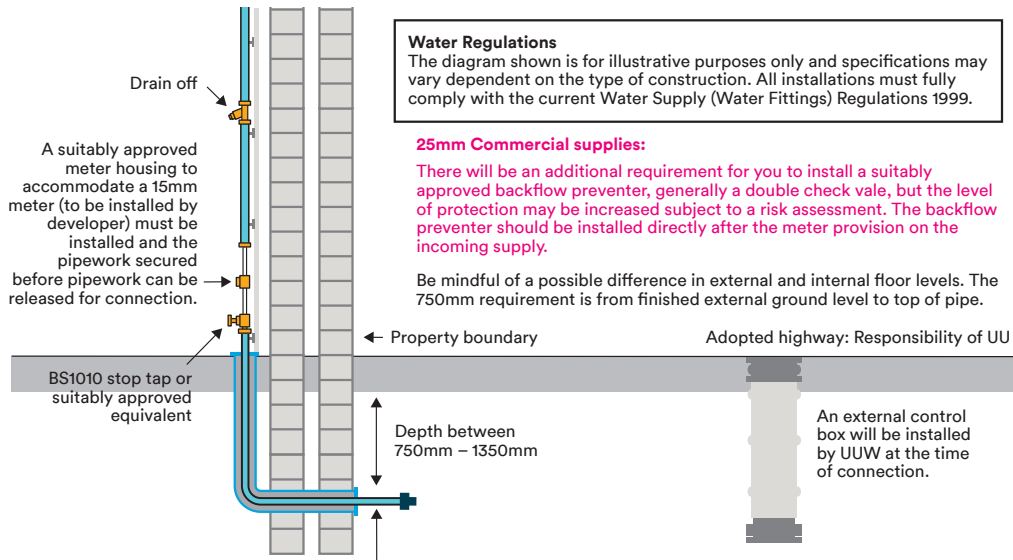

Install duct through or under the foundation wall (750mm from external ground level to top of pipe) without entering into the adopted highway. Duct to be sized to accommodate the service pipe with insulation (where applicable) that meets the minimum requirements. End of the pipe to be sealed with a mechanical stop end. Please be mindful of street furniture.  
**Note:** Someone will need to be on site to pass the pipework through the duct on the day of connection. Duct to be sealed afterwards.

# Multi-occupancy premises – 32mm basement connection fronting on to the adopted highway

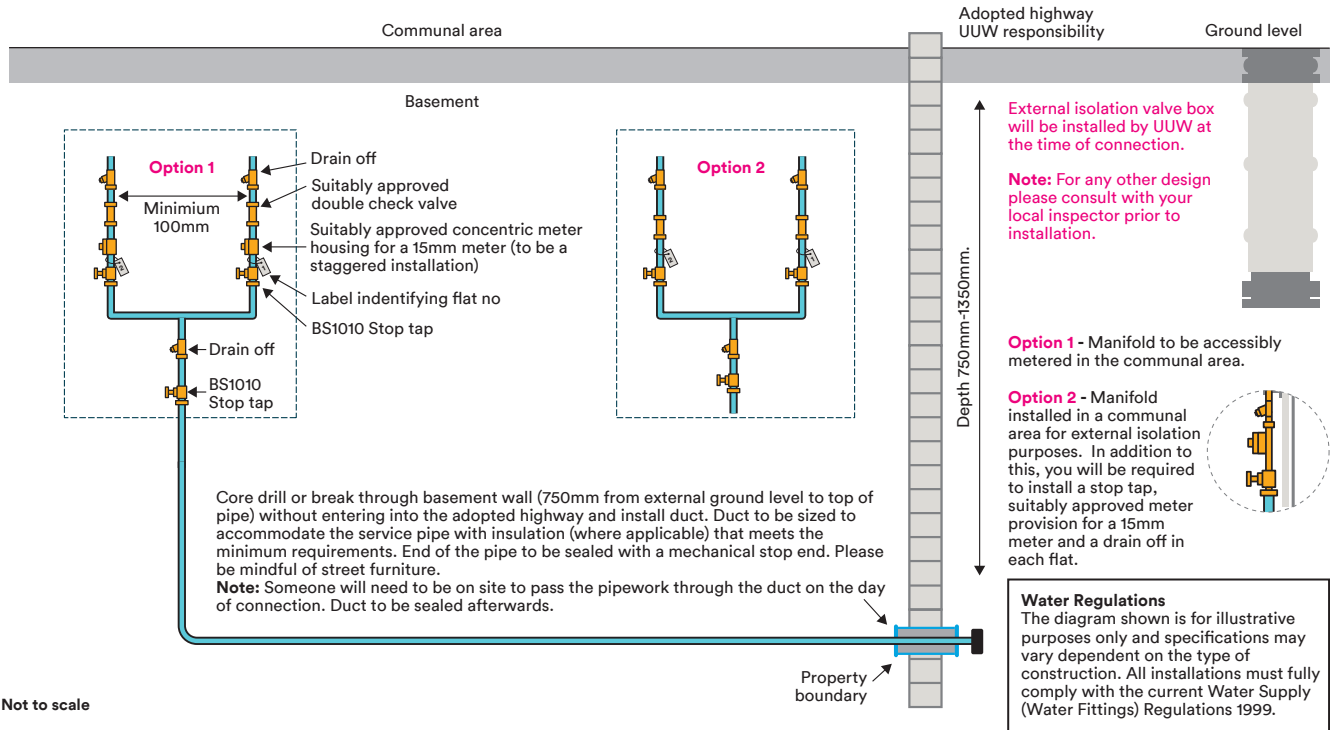

# Multi occupancy premises – 32mm standard connection

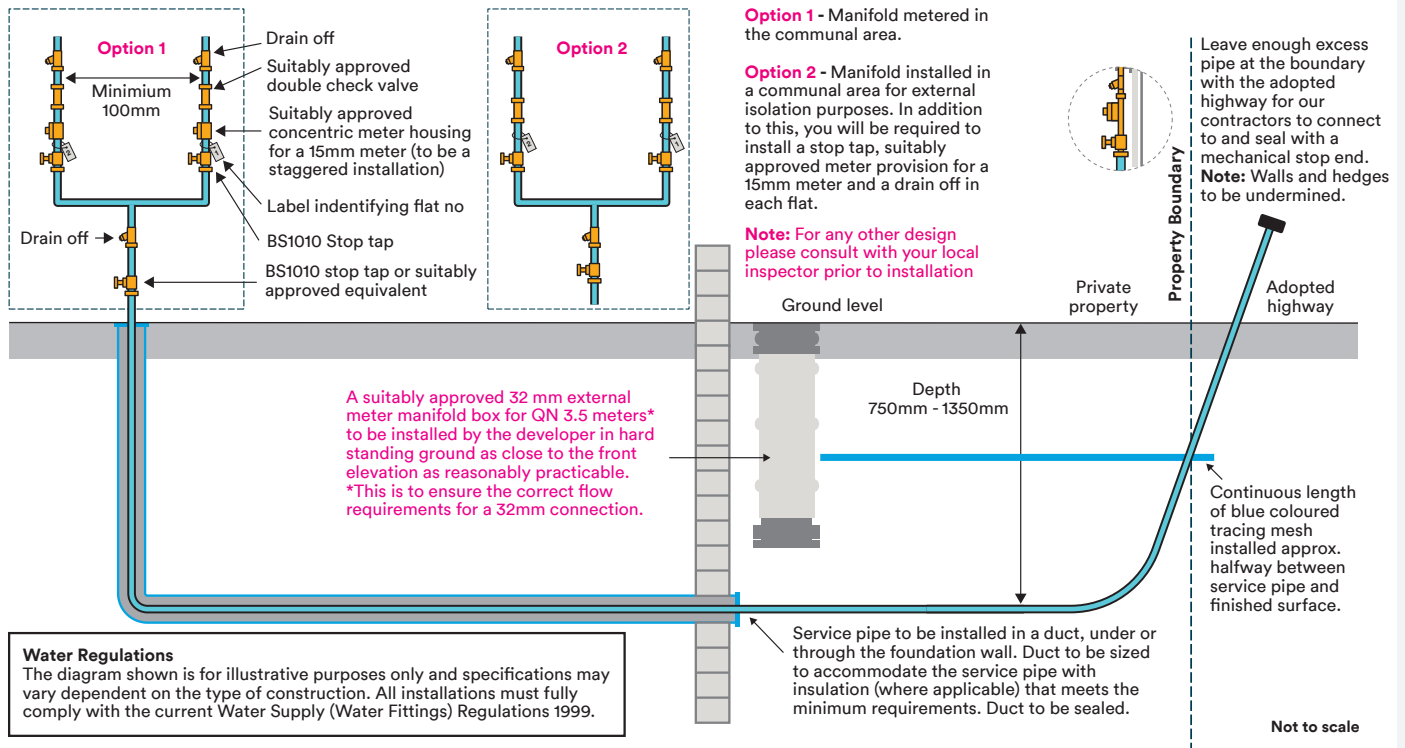

# Incoming water supply pipe installation for large diameter supplies – Pre-formed soft filled pit

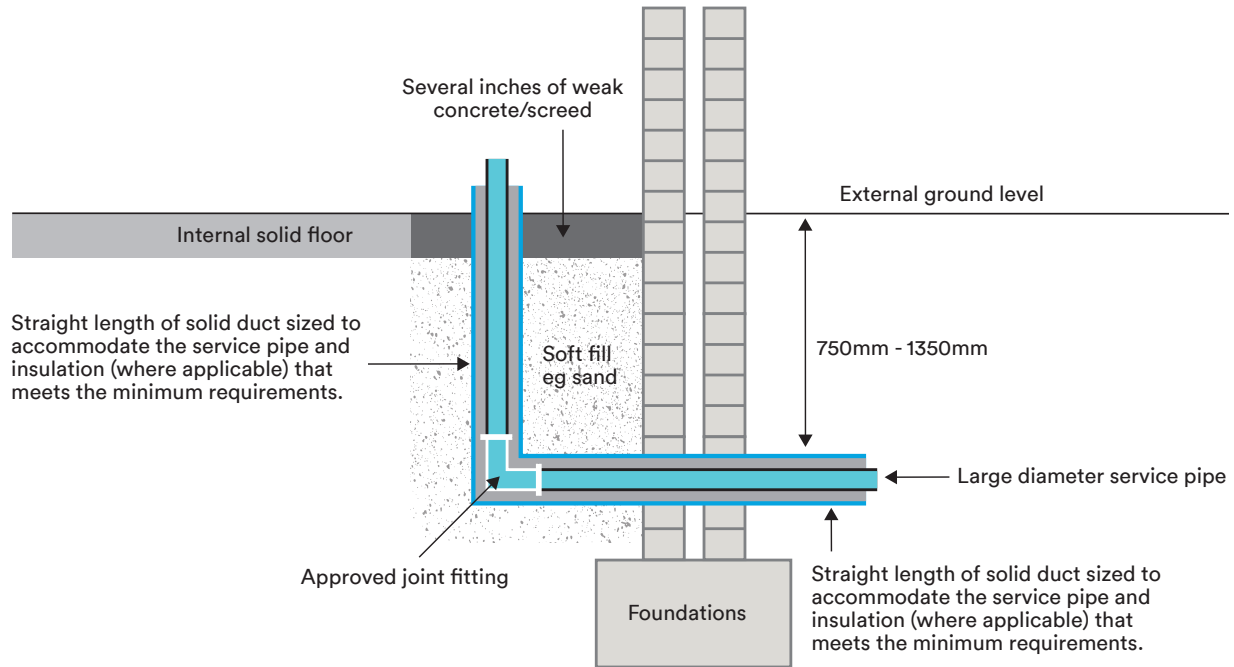

# HMO non-standard 63mm supply with provision for 25mm and 40mm in-line meters

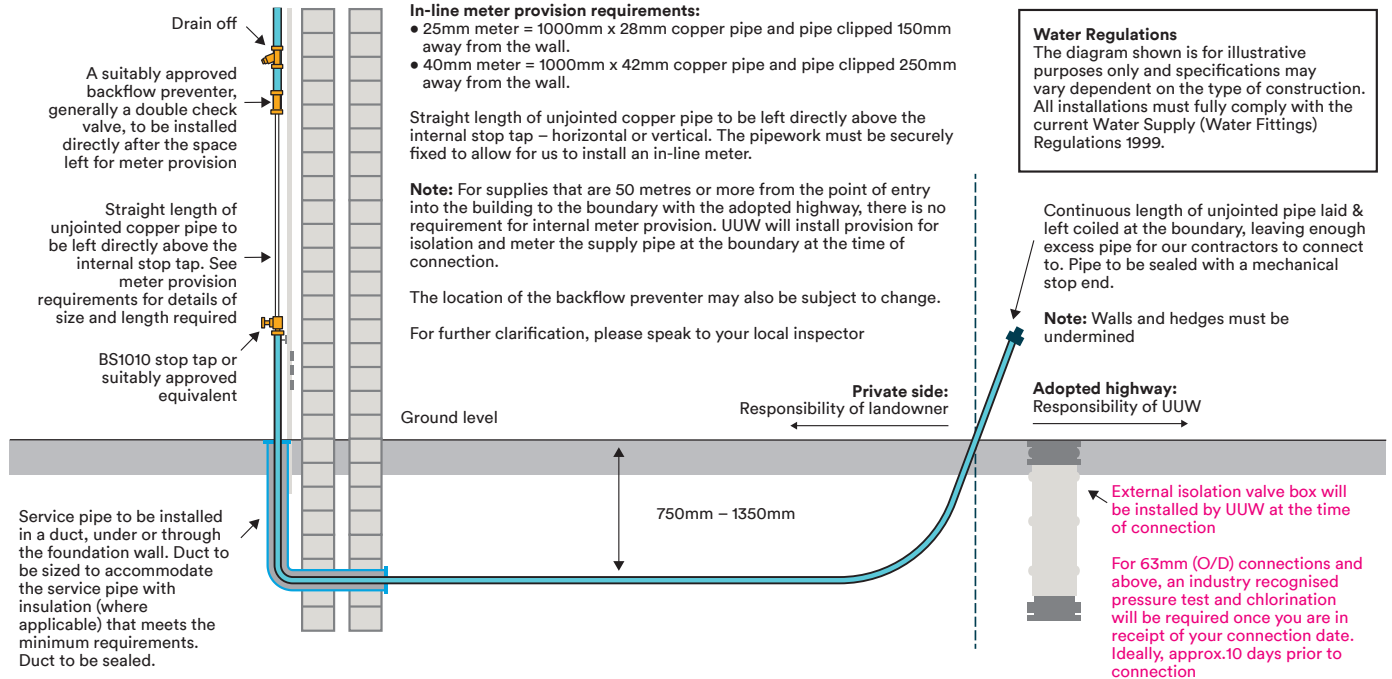

Not to scale



# HMO basement supply fronting on to the adopted highway with provision for 20mm, 25mm and 40mm in-line meters

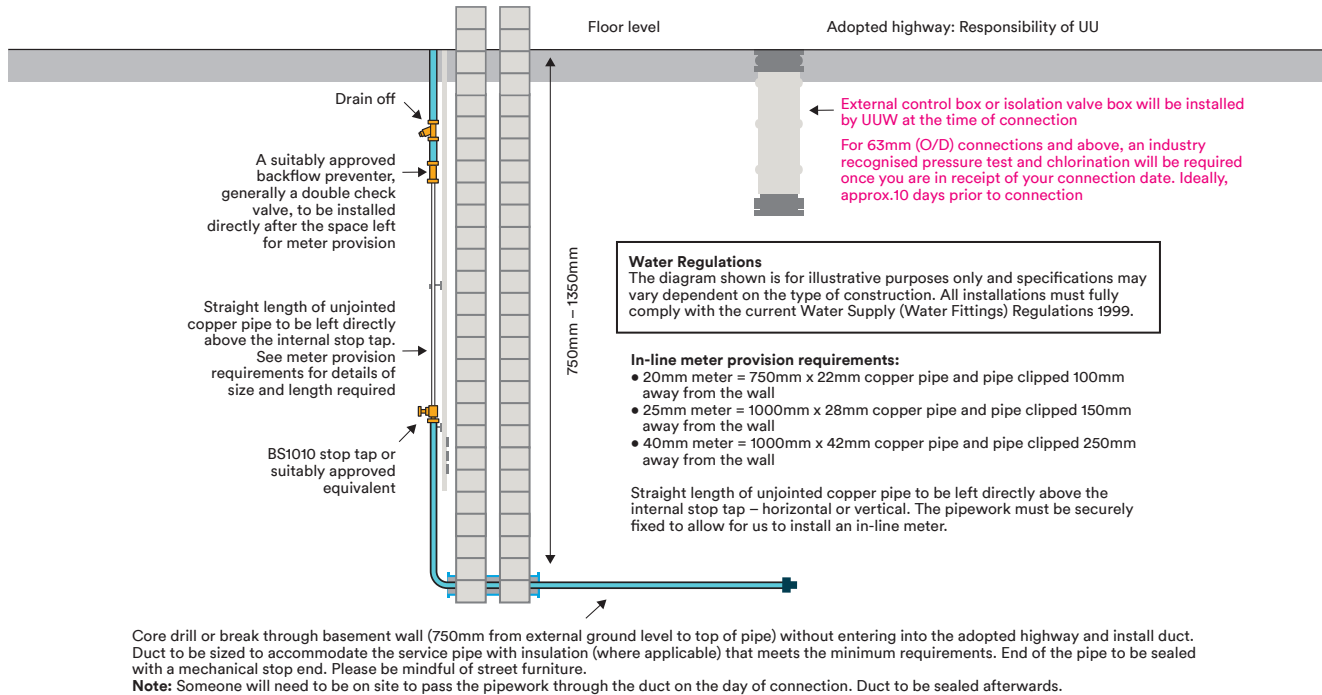

# HMO standard 32mm supply with provision for 20mm and 25mm in-line meters

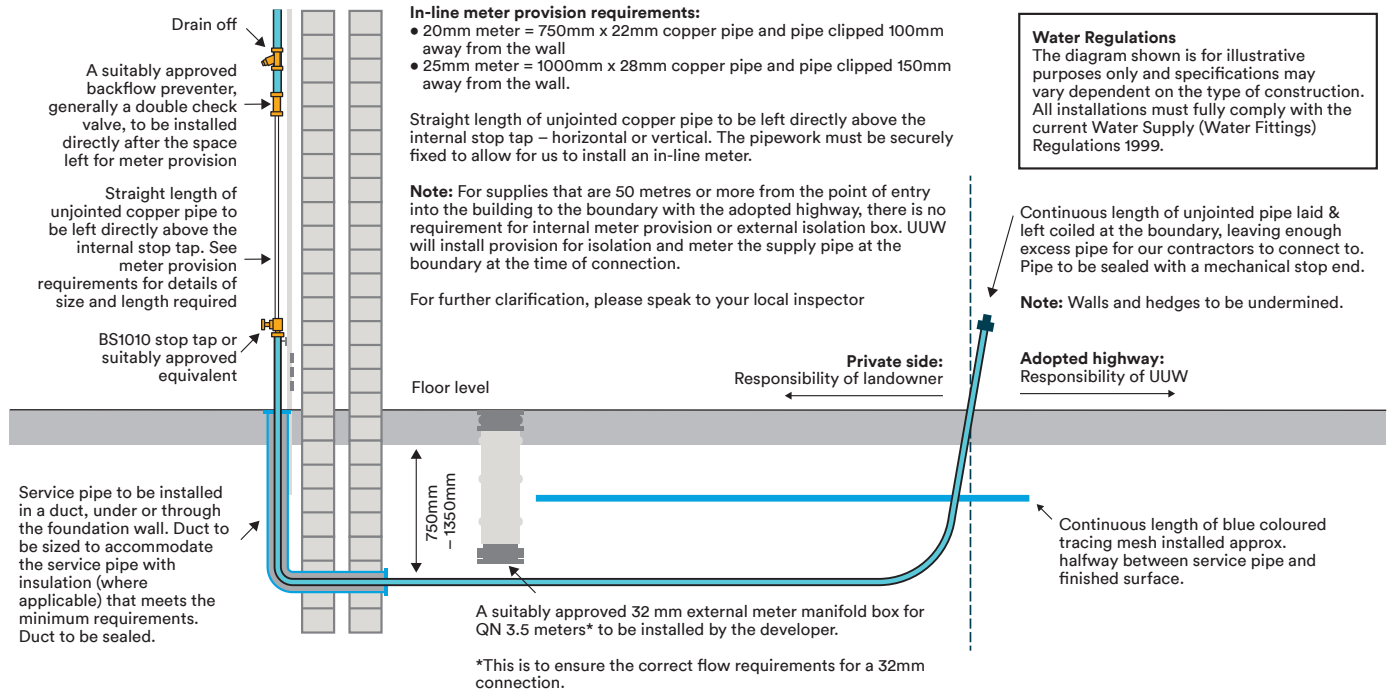

# Temp to perm metered internally

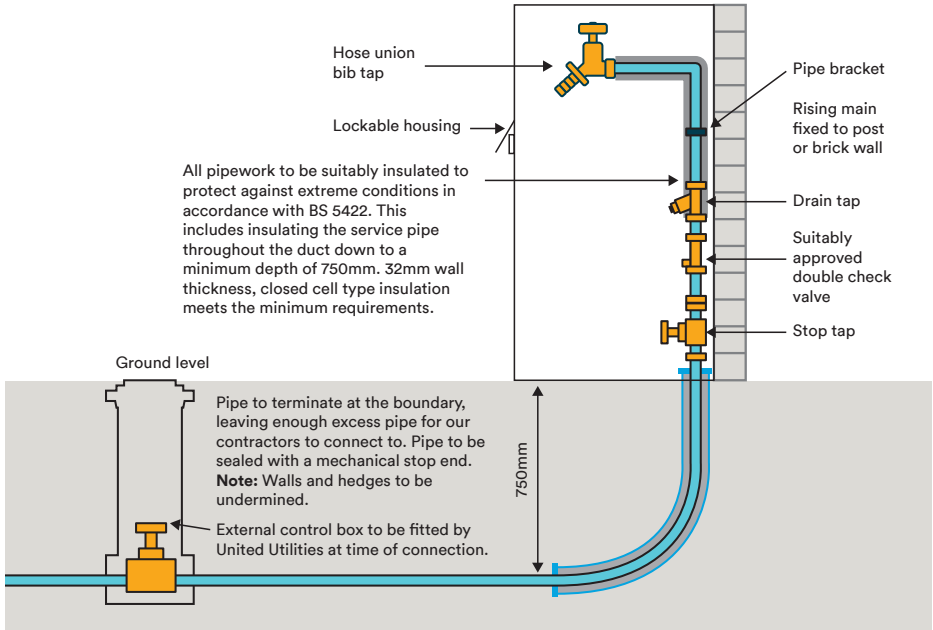

**Important:** All commercial connections will require the installation of a suitably approved backflow preventer, generally a double check valve fitted directly after the first incoming stop tap, but the level of protection may increase and the location may change after a further risk assessment. This is not a standard requirement for single supplies to domestic properties.

**Water Regulations**  
The diagram shown is for illustrative purposes only and specifications may vary dependent on the type of construction. All installations must fully comply with the current Water Supply (Water Fittings) Regulations 1999.

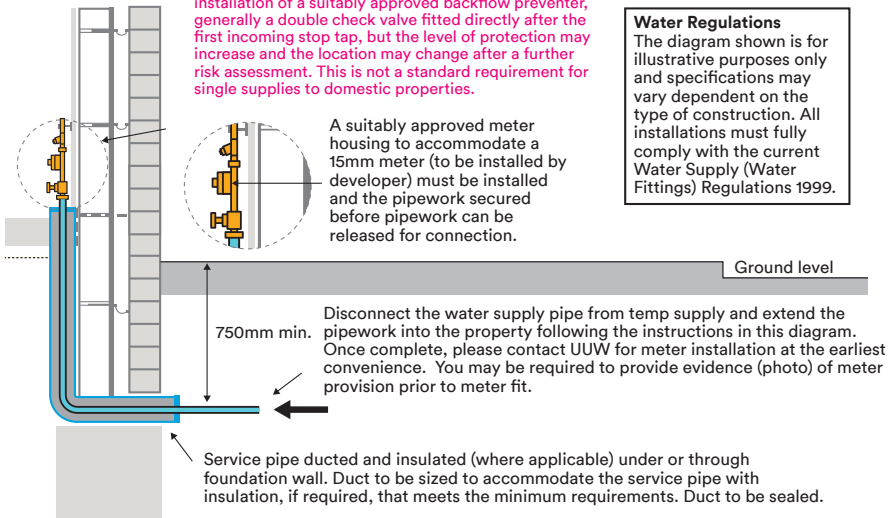

# Temp to perm metered externally

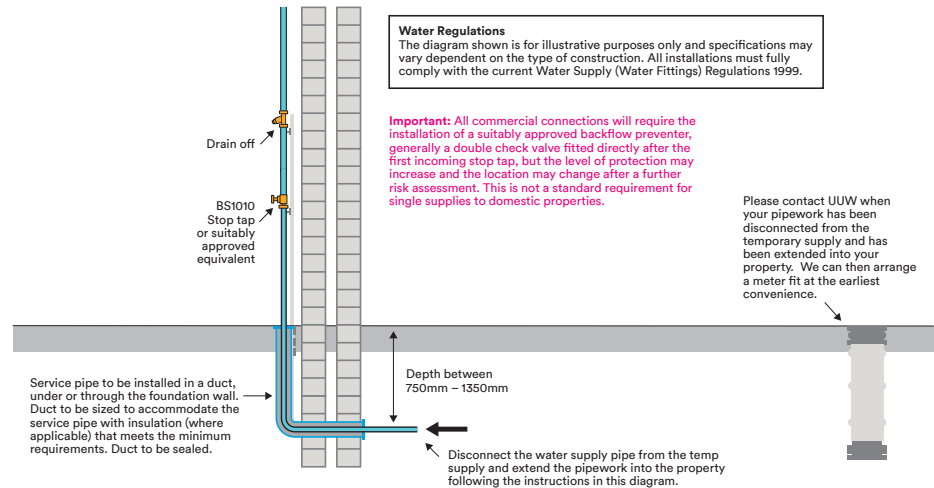
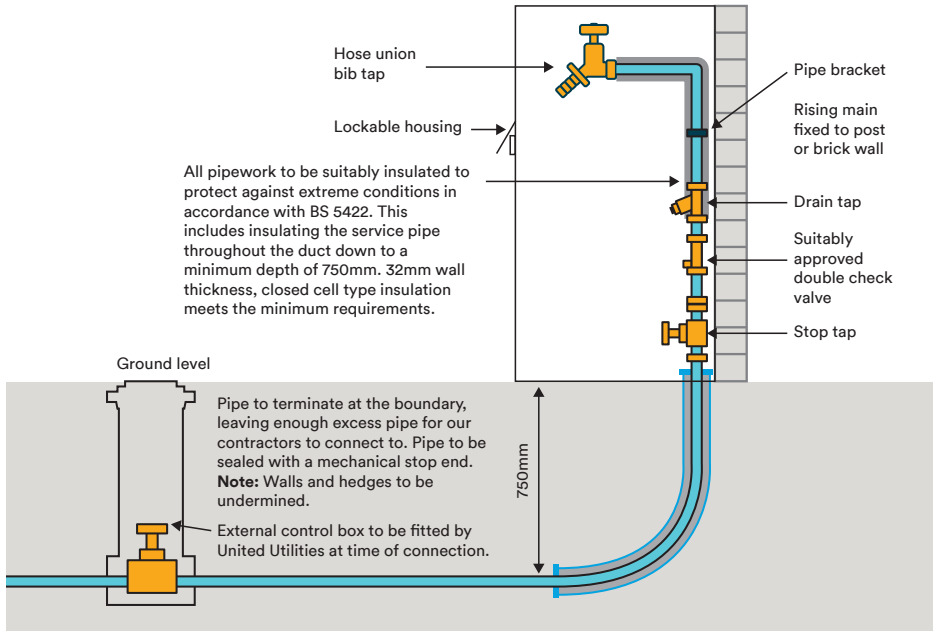

Not to scale

# 32mm commercial supply fronting on to the adopted highway with provision for 20mm and 25mm in-line meters

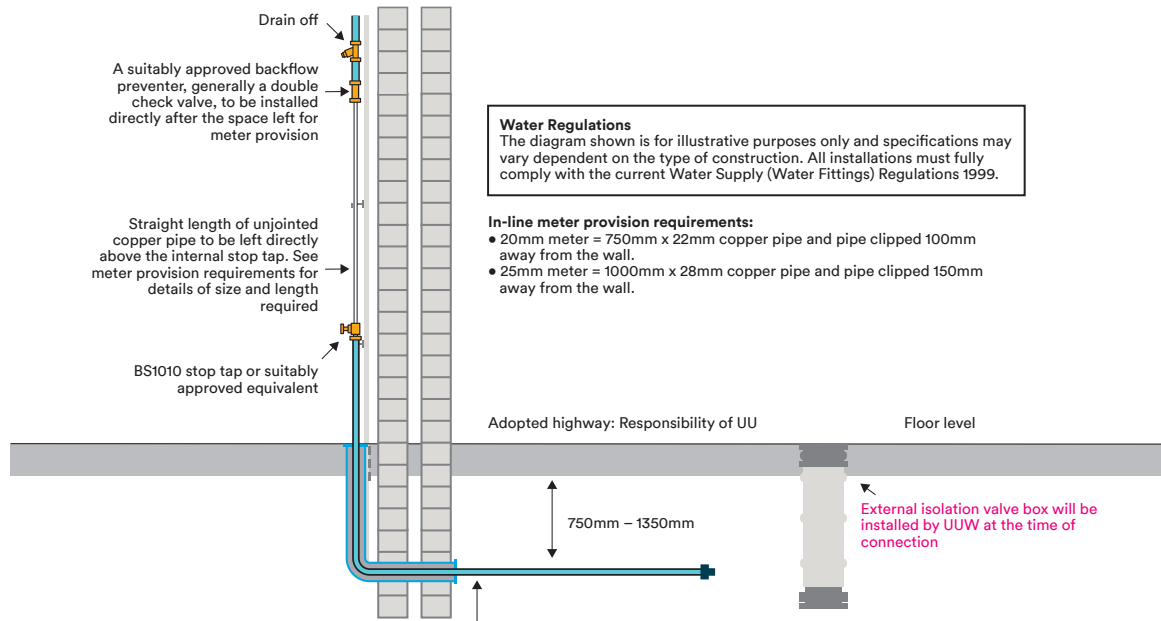

Not to scale

**Water Regulations**  
 The diagram shown is for illustrative purposes only and specifications may vary dependent on the type of construction. All installations must fully comply with the current Water Supply (Water Fittings) Regulations 1999.

- In-line meter provision requirements:**
- 20mm meter = 750mm x 22mm copper pipe and pipe clipped 100mm away from the wall.
  - 25mm meter = 1000mm x 28mm copper pipe and pipe clipped 150mm away from the wall.

A suitably approved backflow preventer, generally a double check valve, to be installed directly after the space left for meter provision

Straight length of unjointed copper pipe to be left directly above the internal stop tap. See meter provision requirements for details of size and length required

BS1010 stop tap or suitably approved equivalent

Adopted highway: Responsibility of UU

Floor level

750mm – 1350mm

External isolation valve box will be installed by UUW at the time of connection

Install duct through or under the foundation wall (a minimum 750mm from external ground level to top of pipe) without entering into the adopted highway. Duct to be sized to accommodate the service pipe with insulation (where applicable) that meets the minimum requirements. End of the pipe to be sealed with a mechanical stop end. Please be mindful of street furniture.

**Note:** Someone will need to be on site to pass the pipework through the duct on the day of connection. Duct to be sealed afterwards.

# Permanent commercial standpipe supply for domestic use only - boundary metered

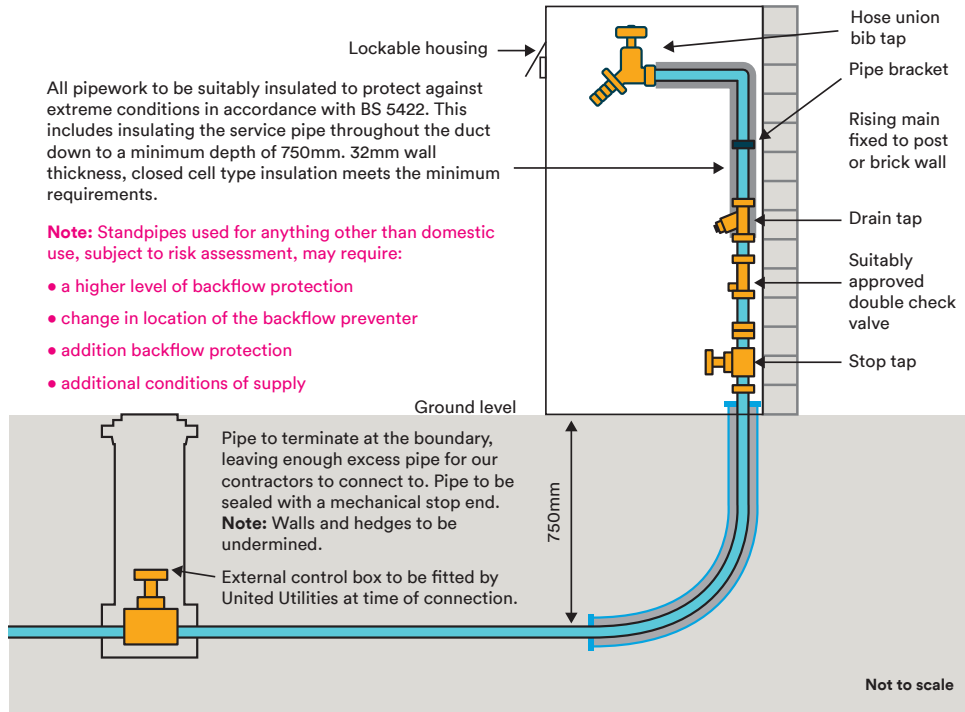

Temporary building supplies must be suitably insulated and housed in a lockable box and the supply pipe should incorporate all the fittings detailed in the diagram on the left.



*This is an example of a lockable box referenced in the spec drawing on the left.*

# Standard 25mm commercial supply with provision for a 15mm internal AMR meter

## UUW 15mm and 20mm meter location policy

### Internal meter installation

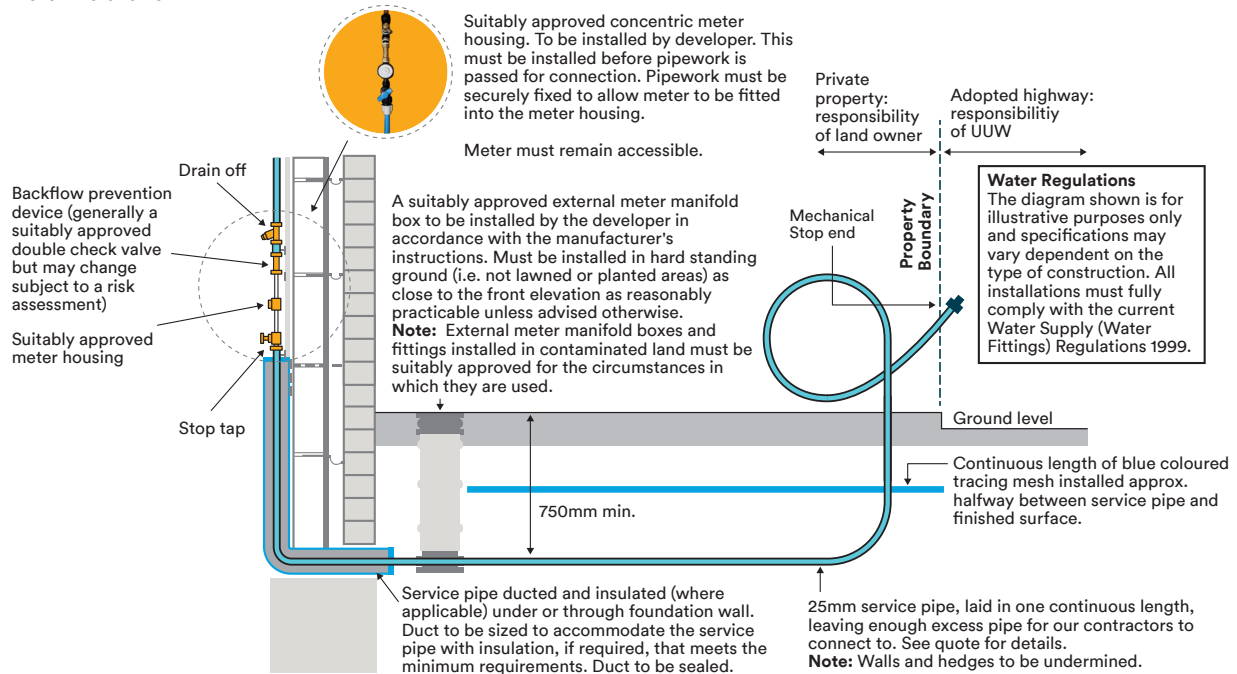

Not to scale

# Rejoin / Service renewal specification

## 1. Internal pipework

- A suitably approved stop tap and drain off must be installed as close as reasonably practicable to the point where the supply enters the property

## 2. Ducting

- Where a supply pipe enters or runs underneath a building it must be installed inside a suitable duct
- The duct should be sized to accommodate the service pipe and insulation where required
- End caps or a readily removable sealant should be used to seal the duct both ends

## 3. Trench

- The trench should be between 750mm-1350mm deep and lined with sand or soft earth, not rubble or sharp objects

## 4. Sealed supply pipe

- The end of the supply pipe must be sealed at the boundary with a mechanical water tight fitting, leaving enough pipe for our contractors to connect to

## 5. Point of connection

- Please lay your new service pipe to the boundary with the adopted highway, as close as reasonably practicable to the existing supply, but no more than a metre either side of it
- Walls and hedges to be undermined

**Please Note: Failure to comply with the above conditions of service may result in a failed inspection and a delay in your connection.**

**For commercial rejoins there will be an additional requirement for the installation of an approved backflow preventer, generally a double check valve, but the level of protection may increase subject to a risk assessment.**

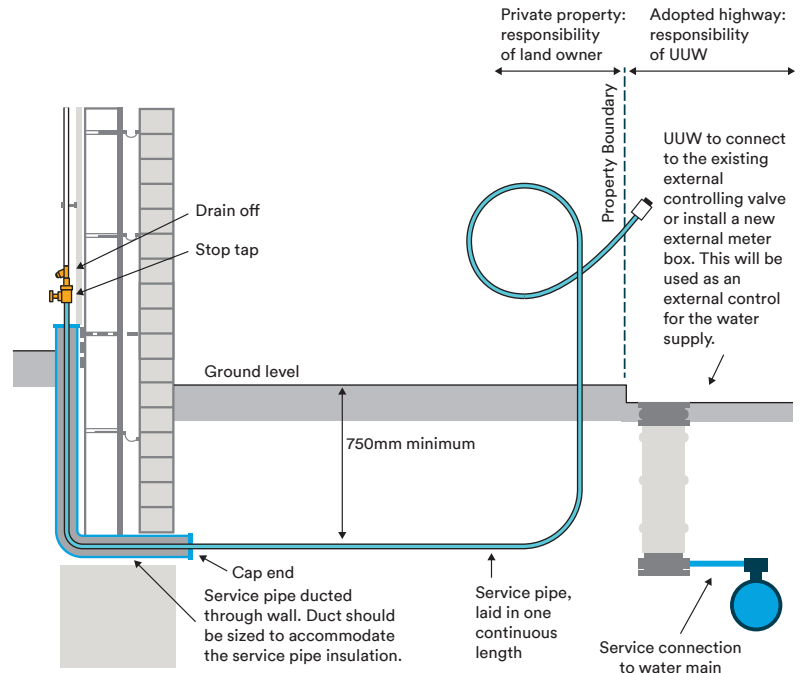

### Water Regulations

The diagram shown is for illustrative purposes only and specifications may vary dependent on the type of construction. All installations must fully comply with the current Water Regulations.

Not to scale